

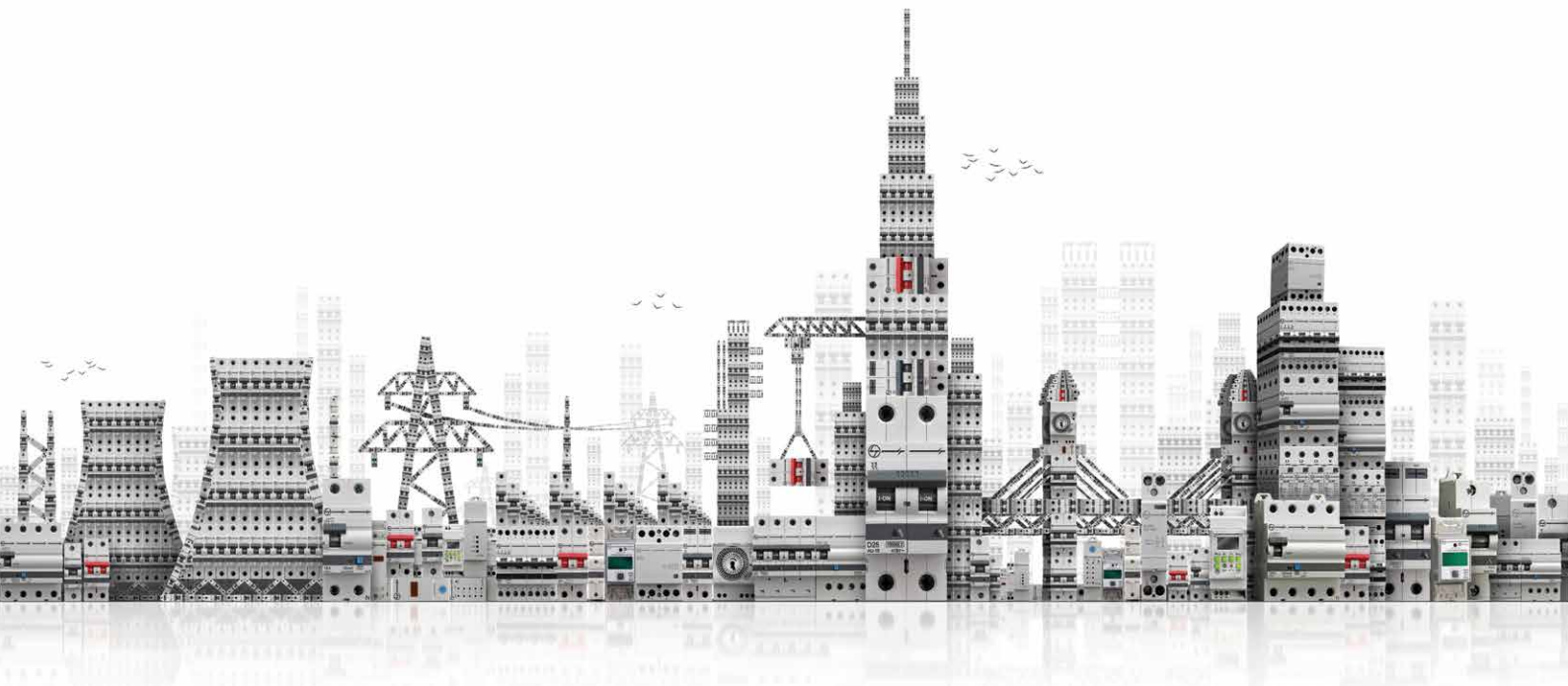



Engineered for the **real world**

**AU Solutions
for Final Distribution**
Protection | Control | Monitoring





Real world technology created by listening to you

Larsen & Toubro is a multi-billion dollar technology, engineering, construction, manufacturing and financial services conglomerate with global operations. The Company's switchgear business is India's leading producer of low-voltage and medium-voltage switchgear for industries, buildings, homes and agriculture, with a track record that spans six decades and 110 countries.

Since the start of our journey, we have listened, observed and experienced our customers' needs. AU Solutions is a range of protection, control and monitoring devices born from the learning gained.

From protection against overload and earth leakage to lightning and switching surges, this range offers more than expected – meeting your needs of today and tomorrow.



Translating technology into **real** benefits



AU Solutions for final distribution offer a unique blend of safety, convenience and performance. Each product in the AU Solutions range is designed to provide lasting benefits.

Lowest Watt Loss

Saves money and natural resources

MCBs from AU Solutions offer the lowest watt loss in the industry. On an average, the watt loss values are almost 55% lower than those prescribed by IEC.

Lower watt loss means lower power consumption, which directly translates into monetary savings. Beyond tangible benefits, lower power requirement also hints at lower consumption of natural resources used for producing energy. In a nutshell, these MCBs are a small, yet significant step towards sustainability.

Maximum Power Loss Per Pole (W)

| Current Ratings (A) | As Per IS/IEC 60898 | For AU Range of MCBs | % lower |
|---------------------|---------------------|----------------------|---------|
| 0.5 | 3 | 1.9 | 38% |
| 1 | 3 | 2 | 33% |
| 1.6 | 3 | 2.1 | 30% |
| 2 | 3 | 2.1 | 30% |
| 3 | 3 | 2.1 | 30% |
| 4 | 3 | 2.1 | 30% |
| 5 | 3 | 2.1 | 30% |
| 6 | 3 | 1.1 | 63% |
| 10 | 3 | 1.2 | 60% |
| 16 | 3.5 | 1.8 | 50% |
| 20 | 4.5 | 1.9 | 58% |
| 25 | 4.5 | 2.1 | 54% |
| 32 | 6 | 2.4 | 60% |
| 40 | 7.5 | 3.1 | 59% |
| 50 | 9 | 4.1 | 54% |
| 63 | 13 | 4.3 | 67% |
| 80 | 15 | 3.9 | 74% |
| 100 | 15 | 6.2 | 59% |
| 125 | 20 | 9.2 | 54% |

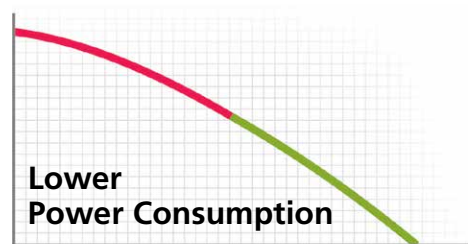

Greater Savings



Towards Sustainability



For reducing extra gases



For driving extra miles



For electrifying extra houses



Short-circuit Fault Indicator

Easy diagnosis, saves downtime

With the unique short-circuit fault indication feature, one can conclude if the MCB has tripped due to a short-circuit fault.

It helps in reducing downtime as the faulty phase and cause of MCB tripping are easily detected.

If the MCB has tripped on 'overload', non-critical loads can be switched OFF before switching the MCB ON again.

In the case of a short-circuit fault, the location and cause of the short-circuit should be identified and the necessary corrective action should be taken.



Quick Connect

Saves time

Quick Connect MCBs offer spring-loaded terminals as against conventional termination.

Both flexible and rigid wires can be terminated by sliding them along the termination groove; no tool is required for terminating the rigid wire.

Quick Connect MCBs can be terminated in a mere 1-2 seconds* as against 10-15 seconds required for standard MCBs.

With Quick Connect MCBs, the installer can achieve a reduction in installation time by around 30%, increasing overall productivity.

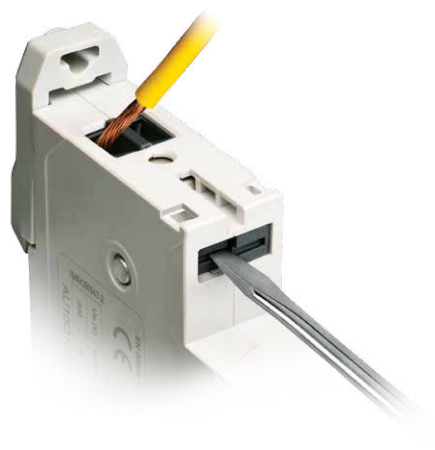

Communication Capability

For smart systems

With the communication capability of AU Solutions, one can monitor and control various devices remotely.

The complete communication system can be deployed for effective energy management.



RoHS Compliance

Environment-friendly

RoHS compliant AU Solutions do not use any substances which are hazardous to the environment.



*Quick Connect section with rigid wire

A comprehensive range for **real world** applications

Real-world applications are varied and spread across segments and geographies.

We, at L&T, are aware that final distribution products are needed for a diverse range of applications – from residential buildings to industrial installations.

Presenting the range that meets all your needs – AU Solutions for Final Distribution!

**Manufactured at L&T's state-of-the-art
facility at Ahmednagar, Maharashtra**

Protection

- MCBs
- RCCBs
- RCBOs
- SPDs

Monitoring

- Accessories
- Energy Meters
- Indicating Lights

Control

- Isolators
- Modular Contactors
- Changeover Switches
- Time Switches
- Automatic Changeover with Current Limiter

AU-COM

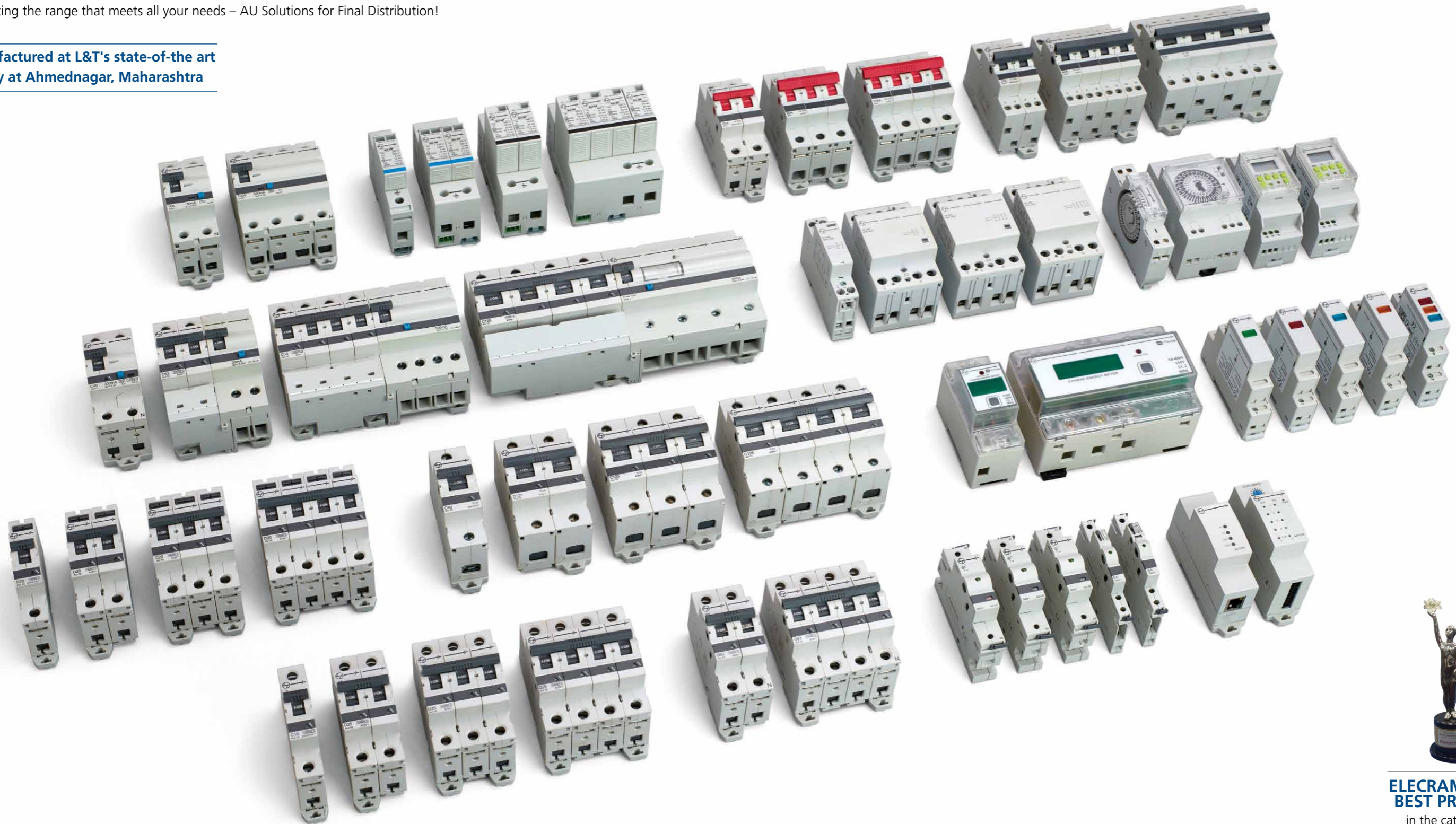





**ELECAMA 2014
BEST PRODUCT**

in the category of
'Product Developed by
an Indian Exhibitor'.

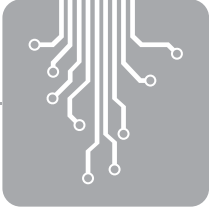

CONTENTS

| | | |
|----------|---|--------------------------------|
| A |  | PROTECTION DEVICES 7 |
| | | MCBs 8 |
| | | RCCBs 15 |
| | | RCBOs 19 |
| | | SPDs 24 |
| B |  | MONITORING DEVICES 28 |
| | | Accessories 29 |
| | | Energy Meters 35 |
| | | Indicating lights 38 |
| C |  | CONTROL DEVICES 40 |
| | | Isolators 41 |
| | | Changeover Switches 44 |
| | | Modular Contactors 47 |
| | | Time Switches 50 |
| | | ACCL 53 |
| D |  | AU-COM 56 |
| | | Communication Solution |
| E |  | TECHNICAL REFERENCES 60 |



PROTECTION DEVICES

Protection devices in the AU Solutions range protect lives and installations from overload, short-circuit, earth leakage, lightning and switching surges.

MCBs

- 0.5A-125A
- B, C, D Curves
- SP, DP, TP, FP, SPN, TPN

RCCBs

- 16A-100A
- 10mA-500mA
- DP, FP
- Type AC, Adi

RCBOs

- 6A-63A
- 10mA-300mA
- DP, FP
- Type AC, Adi

SPDs

- Type 1+2, Type 2
- 1P+N, 3P+N

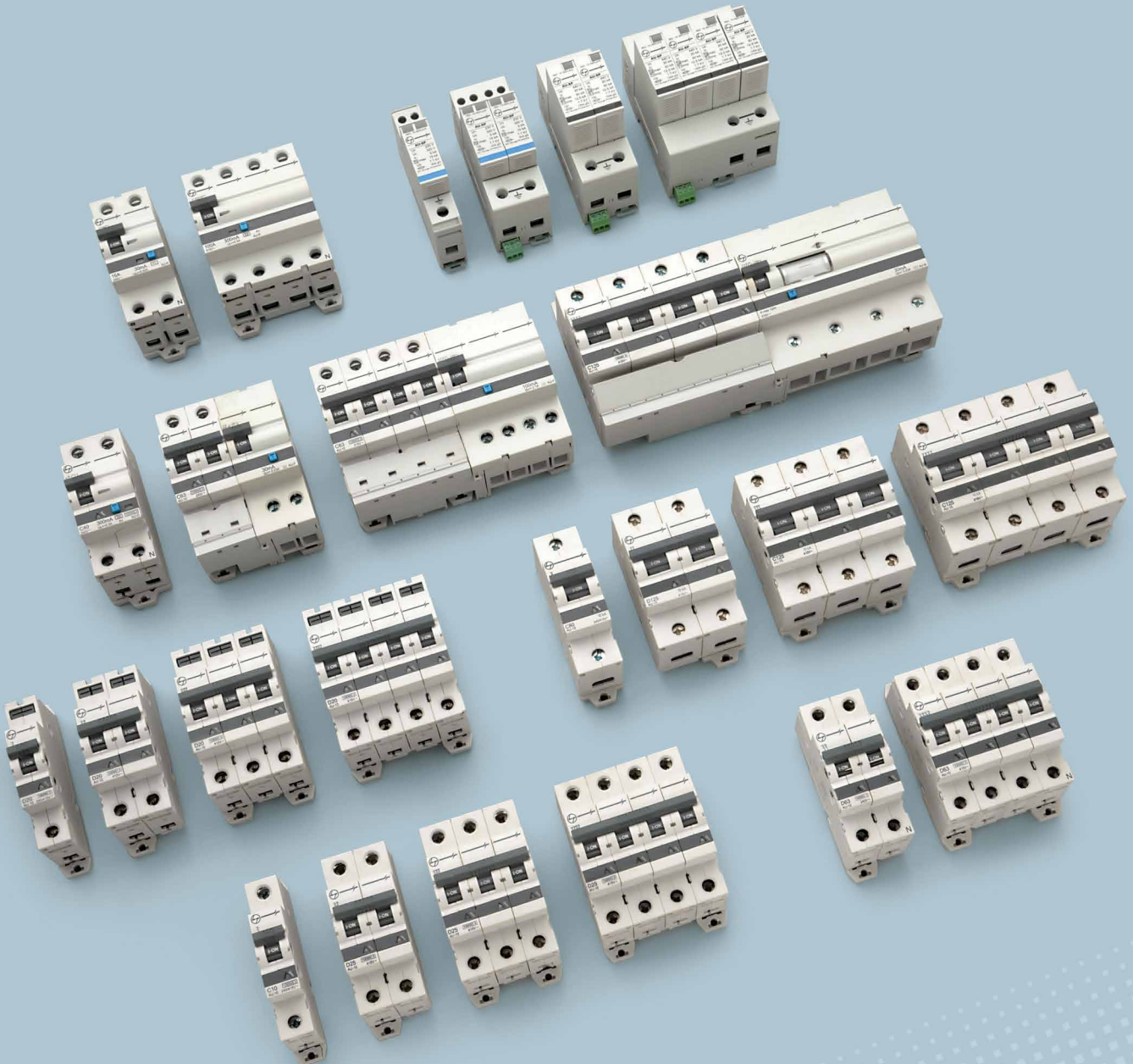



MCBs - Protection with savings

Apart from providing protection against overload and short-circuit faults, the AU range of MCBs is designed to offer the **lowest watt loss** in the industry. This conserves power and helps you save much more than money.

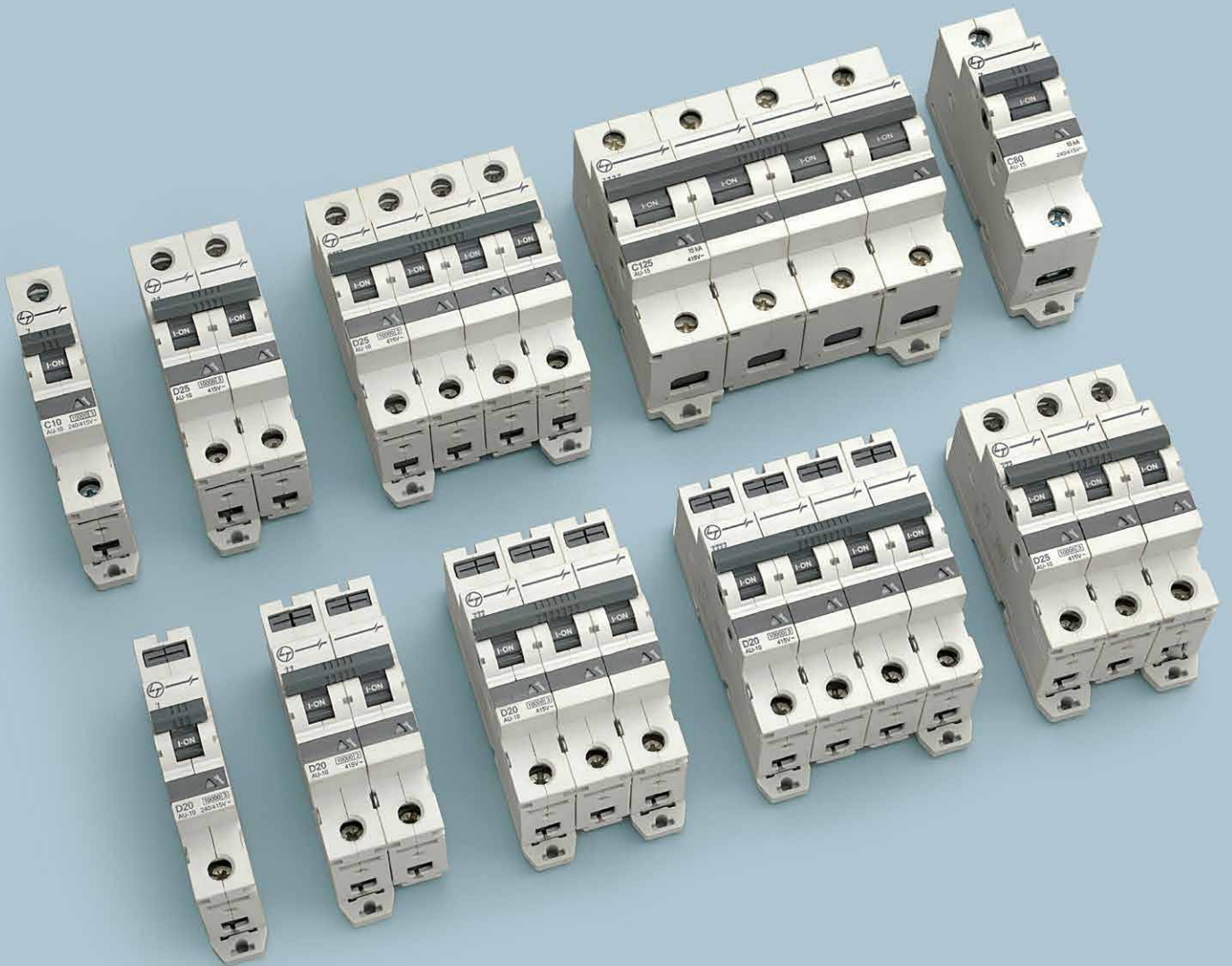

AU-10, AU-15 Range of MCBs



Engineered for higher safety and installation convenience



Unique Benefit

Short-circuit Fault Indication

- Indicates that the MCB has tripped on a short-circuit fault
- Clear indication by amber coloured flag
- Easy detection of occurrence of a short-circuit fault
- Faulty phase detection in multi-pole MCBs
- Clear differentiation between overload and short-circuit fault

Introducing in India



Terminate the cable with just a click

- **'Quick Connect' Design**
 - Both, flexible and rigid wires can be terminated by sliding them along the termination groove; no tool required for terminating the rigid wire.
 - Reduces installation time

Lowest Watt Loss

- MCBs from AU Solutions offer the lowest watt loss in the industry.
- On an average, the watt loss values are almost 55% lower than those prescribed by IEC, and are the lowest among its kind of products.

Ensures Total Safety

- **True Position Indication**
 - Knob indicates actual position of the contacts inside



Ensures Safe Installation

- **Safety Shutter**
 - Avoids incorrect cable insertion



Prevents Unauthorized Access

- **Provision for PadLock**
 - Can be used either in ON or OFF position

Line-Load Reversibility

- Either side can be used to terminate supply or load

MCB Removability with Busbar in place

- A uniquely designed DIN clip, allows easy removal of the DIN mounted MCB while the connection busbar is in place with adjoining devices

Flexibility in Termination

- Bi-connect terminals offer busbar and cable termination on both incoming and outgoing sides

Quick Make-Quick Break, Trip-Free Mechanism

- This feature ensures reliable and safe product functioning



Range Highlights

- Conforms to IS/IEC 60898-1, EN 60898-1, IEC 60898-1 EN 60947-2, IEC 60947-2
- Wide Range of Current Ratings – 0.5A to 125A
- Short-circuit Breaking Capacity
10kA (IEC 60898-1, EN 60898-1)
15kA (IEC 60947-2, EN 60947-2) – for 80A, 100A and 125A
- B, C & D Characteristics
- Available in SP, DP, TP, FP, SPN and TPN
- Suitable for DC Application
- Suitable for Isolation
- Protection Degree - IP 20
- Availability of wide Range of Site Mountable Accessories
- Energy limiting class – 3

Product Specifications

| ELECTRICAL | |
|--|--|
| Tripping Characteristics | B Curve: 6A to 63A C Curve: 0.5A to 125A D Curve: 0.5A to 125A |
| Rated Operational Voltage | 240/415V |
| Rated Insulation Voltage | 500V |
| Rated Impulse Voltage | 6kV |
| Rated Frequency | 50Hz/60Hz |
| Rated Short-circuit Breaking Capacity, AC – 0.5A to 63A IEC 60898-1, EN 60898-1 | 10kA |
| Rated Short-circuit Breaking Capacity, DC – 0.5A to 125A IEC 60947-2 | SP 130V : 10kA DP 250V : 10kA FP 500V : 10kA |
| Rated Short-circuit Breaking Capacity, AC – 80A to 125A IEC 60947-2, EN 60947-2 | 15kA |
| Electrical Life (Operating Cycles) | 20,000 up to 32A 12,000 40A to 63A 5,000 80A to 125A |

| MECHANICAL | |
|---|--|
| Mechanical Life (Operating Cycles) | 20,000 |
| Vibration Resistance (in X, Y, Z direction) | 3g in frequency 10-55Hz, 20 cycles |
| Shock Resistance (in X, Y, Z direction) | 20g, 3 Shocks, with short duration of 10ms |

| INSTALLATION | |
|-------------------|--|
| Terminal Capacity | 35 mm ² (rigid) 25 mm ² (flexible) } up to 63A 70 mm ² (rigid) 50 mm ² (flexible) } 80A to 125A |
| Tightening Torque | 4Nm |
| Mounting Position | Horizontal / Vertical / Flat |

| GENERAL | |
|-------------------------|----------------|
| Pollution Degree | 3 |
| Calibration Temperature | 30°/ 40°/ 50°C |
| Operating Temperature | -25°C to +60°C |

Decoding Product Cat. Nos: AU-10, AU-15

| | | | | | | | | | | | | |
|---------------------------------|----------------------|---------------------------|--------------------|--------------------|------------------|------------------|------------------|------------------|-------------------|-------------------|-------------------|-------------------|
| MCB | AU10 | AU15 | | | | | | | | | | |
| Standard / Quick Connect | S Standard | Q Quick Connect | | | | | | | | | | |
| Number of Poles | 1 1 Pole | 2 2 Pole | 3 3 Pole | 4 4 Pole | S SPN | T TPN | | | | | | |
| Rating (A) | 0E5 0.5A | 001 1A | 1E6 1.6A | 002 2A | 003 3A | 004 4A | 005 5A | 006 6A | 010 10A | 016 16A | 020 20A | 025 25A |
| Calibration | 3 | 30 deg | 4 | 40 deg | 5 | 50 deg | | | | | | |
| Characteristics | B | B Curve | C | C Curve | D | D Curve | | | | | | |

Example







| | | | | | | |
|-----------|----------|-------------|----------|-------------------|------------|-----------|
| MCB, 10kA | Standard | Single Pole | 5A | 50 deg calibrated | D Curve | |
| A | U | 10 | S | 1 | 005 | 5D |

Please contact nearest L&T Branch for products with 40°C and 50°C calibration temperature.









Product Range- Standard Version
 AU-10 | 10kA as per IS/IEC 60898-1

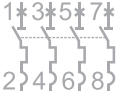

| Description | Rating | Module | Cat. Nos. | | |
|--|--------|--------|--------------|--------------|--------------|
| | | | B Curve | C Curve | D Curve |
| Single Pole   | 0.5A | 1 | - | AU10 S10E53C | AU10 S10E53D |
| | 1A | 1 | - | AU10 S10013C | AU10 S10013D |
| | 1.6A | 1 | - | AU10 S11E63C | AU10 S11E63D |
| | 2A | 1 | - | AU10 S10023C | AU10 S10023D |
| | 3A | 1 | - | AU10 S10033C | AU10 S10033D |
| | 4A | 1 | - | AU10 S10043C | AU10 S10043D |
| | 5A | 1 | - | AU10 S10053C | AU10 S10053D |
| | 6A | 1 | AU10 S10063B | AU10 S10063C | AU10 S10063D |
| | 10A | 1 | AU10 S10103B | AU10 S10103C | AU10 S10103D |
| | 16A | 1 | AU10 S10163B | AU10 S10163C | AU10 S10163D |
| | 20A | 1 | AU10 S10203B | AU10 S10203C | AU10 S10203D |
| | 25A | 1 | AU10 S10253B | AU10 S10253C | AU10 S10253D |
| | 32A | 1 | AU10 S10323B | AU10 S10323C | AU10 S10323D |
| | 40A | 1 | AU10 S10403B | AU10 S10403C | AU10 S10403D |
| | 50A | 1 | AU10 S10503B | AU10 S10503C | AU10 S10503D |
| | 63A | 1 | AU10 S10633B | AU10 S10633C | AU10 S10633D |
| Two Pole   | 0.5A | 2 | - | AU10 S20E53C | AU10 S20E53D |
| | 1A | 2 | - | AU10 S20013C | AU10 S20013D |
| | 1.6A | 2 | - | AU10 S21E63C | AU10 S21E63D |
| | 2A | 2 | - | AU10 S20023C | AU10 S20023D |
| | 3A | 2 | - | AU10 S20033C | AU10 S20033D |
| | 4A | 2 | - | AU10 S20043C | AU10 S20043D |
| | 5A | 2 | - | AU10 S20053C | AU10 S20053D |
| | 6A | 2 | AU10 S20063B | AU10 S20063C | AU10 S20063D |
| | 10A | 2 | AU10 S20103B | AU10 S20103C | AU10 S20103D |
| | 16A | 2 | AU10 S20163B | AU10 S20163C | AU10 S20163D |
| | 20A | 2 | AU10 S20203B | AU10 S20203C | AU10 S20203D |
| | 25A | 2 | AU10 S20253B | AU10 S20253C | AU10 S20253D |
| | 32A | 2 | AU10 S20323B | AU10 S20323C | AU10 S20323D |
| | 40A | 2 | AU10 S20403B | AU10 S20403C | AU10 S20403D |
| | 50A | 2 | AU10 S20503B | AU10 S20503C | AU10 S20503D |
| | 63A | 2 | AU10 S20633B | AU10 S20633C | AU10 S20633D |
| Three Pole   | 0.5A | 3 | - | AU10 S30E53C | AU10 S30E53D |
| | 1A | 3 | - | AU10 S30013C | AU10 S30013D |
| | 1.6A | 3 | - | AU10 S31E63C | AU10 S31E63D |
| | 2A | 3 | - | AU10 S30023C | AU10 S30023D |
| | 3A | 3 | - | AU10 S30033C | AU10 S30033D |
| | 4A | 3 | - | AU10 S30043C | AU10 S30043D |
| | 5A | 3 | - | AU10 S30053C | AU10 S30053D |
| | 6A | 3 | AU10 S30063B | AU10 S30063C | AU10 S30063D |
| | 10A | 3 | AU10 S30103B | AU10 S30103C | AU10 S30103D |
| | 16A | 3 | AU10 S30163B | AU10 S30163C | AU10 S30163D |
| | 20A | 3 | AU10 S30203B | AU10 S30203C | AU10 S30203D |
| | 25A | 3 | AU10 S30253B | AU10 S30253C | AU10 S30253D |
| | 32A | 3 | AU10 S30323B | AU10 S30323C | AU10 S30323D |
| | 40A | 3 | AU10 S30403B | AU10 S30403C | AU10 S30403D |
| | 50A | 3 | AU10 S30503B | AU10 S30503C | AU10 S30503D |
| | 63A | 3 | AU10 S30633B | AU10 S30633C | AU10 S30633D |















| Description | Rating | Module | Cat. Nos. | | |
|---|--------|--------|--------------|--------------|--------------|
| | | | B Curve | C Curve | D Curve |
| Four Pole   | 0.5A | 4 | - | AU10 S40E53C | AU10 S40E53D |
| | 1A | 4 | - | AU10 S40013C | AU10 S40013D |
| | 1.6A | 4 | - | AU10 S41E63C | AU10 S41E63D |
| | 2A | 4 | - | AU10 S40023C | AU10 S40023D |
| | 3A | 4 | - | AU10 S40033C | AU10 S40033D |
| | 4A | 4 | - | AU10 S40043C | AU10 S40043D |
| | 5A | 4 | - | AU10 S40053C | AU10 S40053D |
| | 6A | 4 | AU10 S40063B | AU10 S40063C | AU10 S40063D |
| | 10A | 4 | AU10 S40103B | AU10 S40103C | AU10 S40103D |
| | 16A | 4 | AU10 S40163B | AU10 S40163C | AU10 S40163D |
| | 20A | 4 | AU10 S40203B | AU10 S40203C | AU10 S40203D |
| | 25A | 4 | AU10 S40253B | AU10 S40253C | AU10 S40253D |
| | 32A | 4 | AU10 S40323B | AU10 S40323C | AU10 S40323D |
| | 40A | 4 | AU10 S40403B | AU10 S40403C | AU10 S40403D |
| | 50A | 4 | AU10 S40503B | AU10 S40503C | AU10 S40503D |
| | 63A | 4 | AU10 S40633B | AU10 S40633C | AU10 S40633D |
| SPN   | 0.5A | 2 | - | AU10 SS0E53C | AU10 SS0E53D |
| | 1A | 2 | - | AU10 SS0013C | AU10 SS0013D |
| | 1.6A | 2 | - | AU10 SS1E63C | AU10 SS1E63D |
| | 2A | 2 | - | AU10 SS0023C | AU10 SS0023D |
| | 3A | 2 | - | AU10 SS0033C | AU10 SS0033D |
| | 4A | 2 | - | AU10 SS0043C | AU10 SS0043D |
| | 5A | 2 | - | AU10 SS0053C | AU10 SS0053D |
| | 6A | 2 | AU10 SS0063B | AU10 SS0063C | AU10 SS0063D |
| | 10A | 2 | AU10 SS0103B | AU10 SS0103C | AU10 SS0103D |
| | 16A | 2 | AU10 SS0163B | AU10 SS0163C | AU10 SS0163D |
| | 20A | 2 | AU10 SS0203B | AU10 SS0203C | AU10 SS0203D |
| | 25A | 2 | AU10 SS0253B | AU10 SS0253C | AU10 SS0253D |
| | 32A | 2 | AU10 SS0323B | AU10 SS0323C | AU10 SS0323D |
| | 40A | 2 | AU10 SS0403B | AU10 SS0403C | AU10 SS0403D |
| | 50A | 2 | AU10 SS0503B | AU10 SS0503C | AU10 SS0503D |
| | 63A | 2 | AU10 SS0633B | AU10 SS0633C | AU10 SS0633D |
| TPN   | 0.5A | 4 | - | AU10 ST0E53C | AU10 ST0E53D |
| | 1A | 4 | - | AU10 ST0013C | AU10 ST0013D |
| | 1.6A | 4 | - | AU10 ST1E63C | AU10 ST1E63D |
| | 2A | 4 | - | AU10 ST0023C | AU10 ST0023D |
| | 3A | 4 | - | AU10 ST0033C | AU10 ST0033D |
| | 4A | 4 | - | AU10 ST0043C | AU10 ST0043D |
| | 5A | 4 | - | AU10 ST0053C | AU10 ST0053D |
| | 6A | 4 | AU10 ST0063B | AU10 ST0063C | AU10 ST0063D |
| | 10A | 4 | AU10 ST0103B | AU10 ST0103C | AU10 ST0103D |
| | 16A | 4 | AU10 ST0163B | AU10 ST0163C | AU10 ST0163D |
| | 20A | 4 | AU10 ST0203B | AU10 ST0203C | AU10 ST0203D |
| | 25A | 4 | AU10 ST0253B | AU10 ST0253C | AU10 ST0253D |
| | 32A | 4 | AU10 ST0323B | AU10 ST0323C | AU10 ST0323D |
| | 40A | 4 | AU10 ST0403B | AU10 ST0403C | AU10 ST0403D |
| | 50A | 4 | AU10 ST0503B | AU10 ST0503C | AU10 ST0503D |
| | 63A | 4 | AU10 ST0633B | AU10 ST0633C | AU10 ST0633D |



Product Range- Quick Connect
AU-10 | 10kA as per IS/IEC 60898-1



| Description | Rating | Module | Cat. Nos. | |
|--|--------|--------|--------------|--------------|
| | | | B Curve | C Curve |
|  <p>Single Pole</p>  | 6A | 1 | AU10 Q10063B | AU10 Q10063C |
| | 10A | 1 | AU10 Q10103B | AU10 Q10103C |
| | 16A | 1 | AU10 Q10163B | AU10 Q10163C |
| | 20A | 1 | AU10 Q10203B | AU10 Q10203C |
|  <p>Two Pole</p>  | 6A | 2 | AU10 Q20063B | AU10 Q20063C |
| | 10A | 2 | AU10 Q20103B | AU10 Q20103C |
| | 16A | 2 | AU10 Q20163B | AU10 Q20163C |
| | 20A | 2 | AU10 Q20203B | AU10 Q20203C |
|  <p>Three Pole</p>  | 6A | 3 | AU10 Q30063B | AU10 Q30063C |
| | 10A | 3 | AU10 Q30103B | AU10 Q30103C |
| | 16A | 3 | AU10 Q30163B | AU10 Q30163C |
| | 20A | 3 | AU10 Q30203B | AU10 Q30203C |
|  <p>Four Pole</p>  | 6A | 4 | AU10 Q40063B | AU10 Q40063C |
| | 10A | 4 | AU10 Q40103B | AU10 Q40103C |
| | 16A | 4 | AU10 Q40163B | AU10 Q40163C |
| | 20A | 4 | AU10 Q40203B | AU10 Q40203C |
|  <p>SPN</p>  | 6A | 2 | AU10 QS0063B | AU10 QS0063C |
| | 10A | 2 | AU10 QS0103B | AU10 QS0103C |
| | 16A | 2 | AU10 QS0163B | AU10 QS0163C |
| | 20A | 2 | AU10 QS0203B | AU10 QS0203C |
|  <p>TPN</p>  | 6A | 4 | AU10 QT0063B | AU10 QT0063C |
| | 10A | 4 | AU10 QT0103B | AU10 QT0103C |
| | 16A | 4 | AU10 QT0163B | AU10 QT0163C |
| | 20A | 4 | AU10 QT0203B | AU10 QT0203C |

Dimension Details – Quick Connect MCBs

in mm

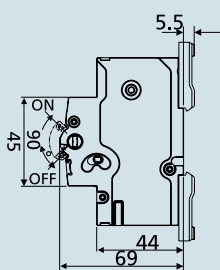

SIDE VIEW



1 POLE



2 POLE / SPN



3 POLE

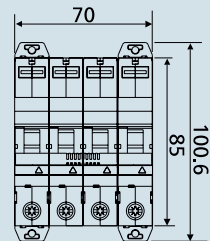









4 POLE / TPN



Product Range- High Rating MCBs
 AU-15 | 15kA as per IEC 60947-2



| Description | Rating | Module | Cat. Nos. | |
|--|--------|--------|--------------|--------------|
| | | | C Curve | D Curve |
|  <p>Single Pole</p>  | 80A | 1.5 | AU15 S10803C | AU15 S10803D |
| | 100A | 1.5 | AU15 S11003C | AU15 S11003D |
| | 125A | 1.5 | AU15 S11253C | AU15 S11253D |
|  <p>Two Pole</p>  | 80A | 3 | AU15 S20803C | AU15 S20803D |
| | 100A | 3 | AU15 S21003C | AU15 S21003D |
| | 125A | 3 | AU15 S21253C | AU15 S21253D |
|  <p>Three Pole</p>  | 80A | 4.5 | AU15 S30803C | AU15 S30803D |
| | 100A | 4.5 | AU15 S31003C | AU15 S31003D |
| | 125A | 4.5 | AU15 S31253C | AU15 S31253D |
|  <p>Four Pole</p>  | 80A | 6 | AU15 S40803C | AU15 S40803D |
| | 100A | 6 | AU15 S41003C | AU15 S41003D |
| | 125A | 6 | AU15 S41253C | AU15 S41253D |

Dimension Details – High Rating MCBs

in mm

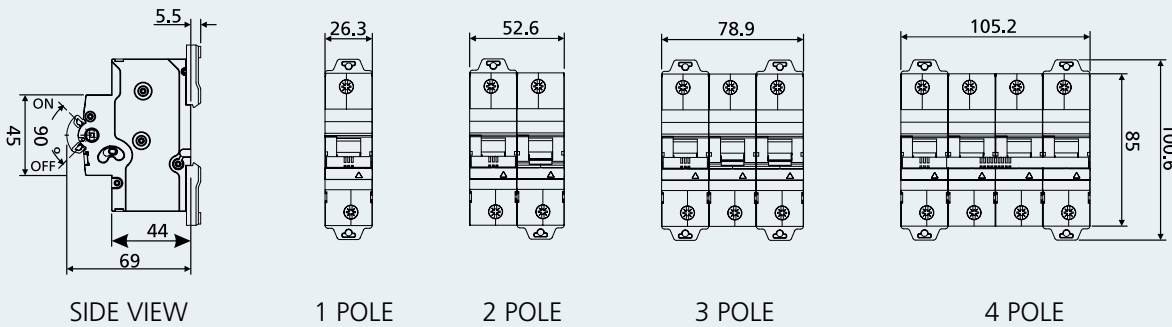

Dimension Details – Standard Version

in mm

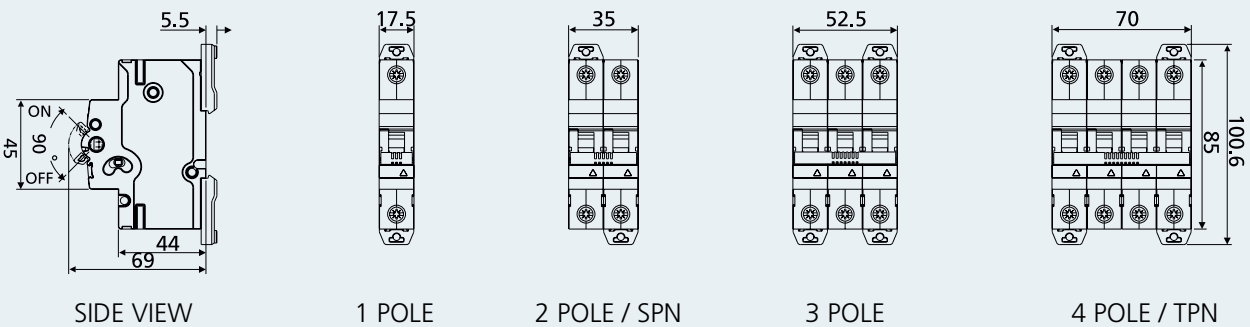



RCCBs - Conditioned for every condition

A sensitivity range from **10mA to 500mA** with Type **AC** and **Adi** (Added Immunity) makes the AU Solutions range of RCCBs suitable for applications ranging from household to industrial.





Suitable for varied applications

- Type AC- For standard installations
- Type Adi - For installations with pulsating DC along with transients and harmonics, such as IT parks and data centres

Designed for ease

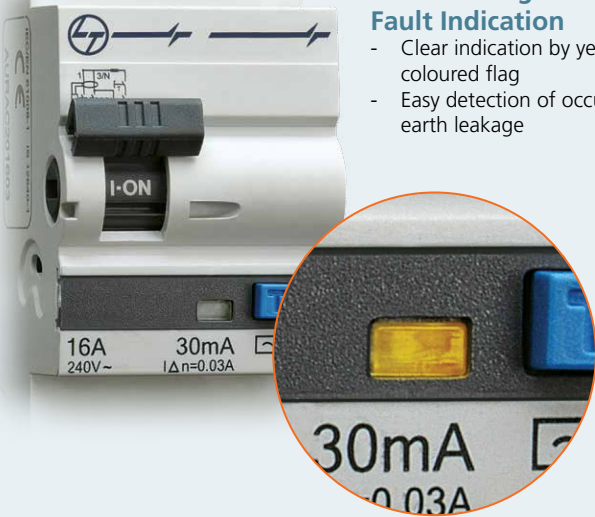

Earth Leakage Fault Indication

- Clear indication by yellow coloured flag
- Easy detection of occurrence of earth leakage

Flexibility

- **Flexibility in Termination**
 - Bi-connect terminals offer busbar or cable termination at both incoming and outgoing sides
- **Line-Load Reversibility**
 - Either of the sides of an RCCB can be used to terminate supply or load
- **RCCBs removability with busbar in place**
 - This feature, with a uniquely designed DIN clip, offers easy removal of DIN mounted RCCBs while the connection busbar is in place with adjoining devices
 - Offers great flexibility in installation process
 - Reduces installation time

Engineered for safety



Ensures Safe Installation

- **Safety Shutter**
 - Avoids incorrect cable insertion, ensuring safe installation



Prevents Unauthorized Access

- **Provision for Padlock**
 - A padlock can be used either in ON or OFF position to meet specific requirements

Trip-free Mechanism

- Ensures reliable and safe product functioning

Advanced Neutral Mechanism

- This feature prevents voltage unbalance in the system, thus protecting equipment downstream



Range Highlights

- Conforms to IEC 61008-1, EN 61008-1, IS 12640-1
- Wide range of current ratings – 16A to 100A
- Precise sensitivities for a variety of applications - from 10mA to 500mA
- Available in
 - Type AC
 - Type Adi
- 2P & 4P versions
- Suitable for Isolation
- Protection Degree - IP 20
- Availability for a wide range of site mountable accessories

Product Specifications

| ELECTRICAL | |
|---|-----------|
| Rated Operational Voltage | 240/415V |
| Rated Insulation Voltage | 500V |
| Rated Impulse Voltage | 6kV |
| Rated Frequency | 50Hz/60Hz |
| Rated Residual Making & Breaking capacity | 1kA |
| Rated Conditional SC Current | 10kA |
| Electrical Life (Operating Cycles) | 10,000 |

| GENERAL | |
|-----------------------|--|
| Operating Temperature | AC Type: -5°C to +60°C Adi Type: -25°C to +60°C |

| MECHANICAL | |
|---|---|
| Mechanical Life (Operating Cycles) | 20,000 |
| Vibration Resistance (in X, Y, Z direction) | 1.5g, 30min, 5-80Hz |
| Shock Resistance (in X, Y, Z direction) | 20g, 3 Shocks, with short duration of 5ms |

| INSTALLATION | |
|-------------------|--|
| Pollution Degree | 3 |
| Terminal Capacity | 35 mm ² (rigid) / 25 mm ² (flexible) } up to 63A 50 mm ² (rigid) / 35 mm ² (flexible) } 80A to 100A |
| Tightening Torque | 4Nm |
| Mounting Position | Horizontal / Vertical / Flat |

Decoding Product CAT Nos.: AU-R

| | | | | | | |
|------------------------|--------------------|--------------------|--------------------|--------------------|--------------------|--------------------|
| RCCB | AU R | | | | | |
| TYPE | AC AC | AD Adi | | | | |
| Number of Poles | 2 2 Pole | 4 4 Pole | | | | |
| Rating (A) | 016 16A | 025 25A | 040 40A | 063 63A | 080 80A | 100 100A |
| Sensitivity | 01 10mA | 03 30mA | 10 100mA | 30 300mA | 50 500mA | |

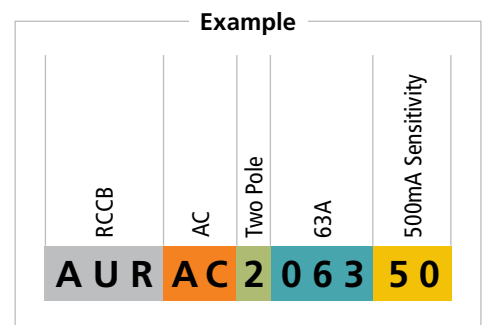



Product Range: AU-R



| Description | Type | Rating | Module | 10 mA | 30 mA | 100 mA | 300 mA | 500 mA |
|--|----------|--------|--------|-------------|-------------|-------------|-------------|-------------|
|  Two Pole | 2P AC | 16A | 2 | AURAC201601 | - | - | - | - |
| | | 25A | 2 | - | AURAC202503 | AURAC202510 | AURAC202530 | AURAC202550 |
| | | 40A | 2 | - | AURAC204003 | AURAC204010 | AURAC204030 | AURAC204050 |
| | | 63A | 2 | - | AURAC206303 | AURAC206310 | AURAC206330 | AURAC206350 |

| | | | | | | | | |
|---|----------|-----|---|---|-------------|-------------|-------------|-------------|
|  Four Pole | 4P AC | 25A | 4 | - | AURAC402503 | AURAC402510 | AURAC402530 | AURAC402550 |
| | | 40A | 4 | - | AURAC404003 | AURAC404010 | AURAC404030 | AURAC404050 |
| | | 63A | 4 | - | AURAC406303 | AURAC406310 | AURAC406330 | AURAC406350 |



| Description | Type | Rating | Module | 10 mA | 30 mA | 100 mA | 300 mA | 500 mA |
|-------------|------|--------|--------|-------|-------------|-------------|-------------|--------|
| Two Pole | 2P | 80A | 2 | - | AURAC208003 | AURAC208010 | AURAC208030 | - |
| | AC | 100A | 2 | - | AURAC210003 | AURAC210010 | AURAC210030 | - |

| | | | | | | | | |
|-----------|----|------|---|---|-------------|-------------|-------------|-------------|
| Four Pole | 4P | 80A | 4 | - | AURAC408003 | AURAC408010 | AURAC408030 | AURAC408050 |
| | AC | 100A | 4 | - | AURAC410003 | AURAC410010 | AURAC410030 | AURAC410050 |

| Description | Type | Rating | Module | 10 mA | 30 mA | 100 mA | 300 mA | 500 mA |
|--|-----------|--------|--------|-------|-------------|-------------|-------------|--------|
|  Two Pole | 2P Adi | 25A | 2 | - | AURAD202503 | AURAD202510 | AURAD202530 | - |
| | | 40A | 2 | - | AURAD204003 | AURAD204010 | AURAD204030 | - |
| | | 63A | 2 | - | AURAD206303 | AURAD206310 | AURAD206330 | - |
| | | 100A | 2 | - | AURAD210003 | - | - | - |

| | | | | | | | | |
|---|-----------|------|---|---|-------------|-------------|-------------|---|
|  Four Pole | 4P Adi | 25A | 4 | - | AURAD402503 | AURAD402510 | AURAD402530 | - |
| | | 40A | 4 | - | AURAD404003 | AURAD404010 | AURAD404030 | - |
| | | 63A | 4 | - | AURAD406303 | AURAD406310 | AURAD406330 | - |
| | | 100A | 4 | - | AURAD410003 | - | AURAD410030 | - |

Circuit Diagram

Two Pole

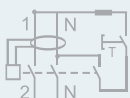

Four Pole



Dimension Details – RCCBs

in mm

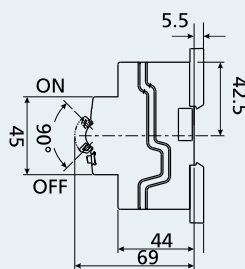

SIDE VIEW



2 POLE

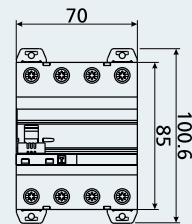

4 POLE



RCBOs - Enhanced Safety

The AU Solutions range RCBOs provides protection from overload, short-circuit and earth leakage.





Benefits you can count on

Greater Convenience

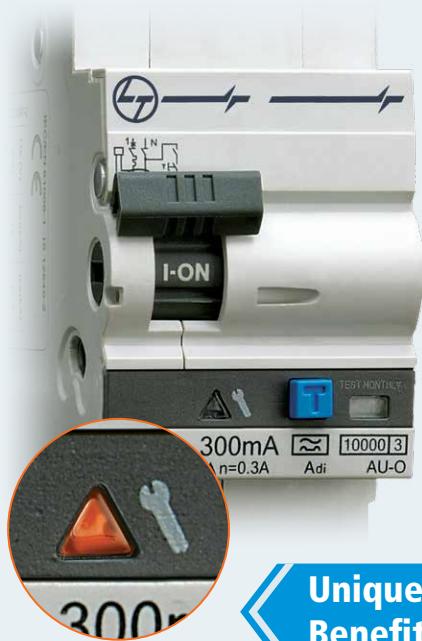

Unique Benefit

- **Short-circuit Fault Indication**
 - Indicates that the breaker has tripped on a short-circuit fault
 - Clear indication by amber coloured flag
 - Easy detection of occurrence of short-circuit fault



- **Earth Leakage Fault Indication**
 - To indicate that the device has tripped due to an earth leakage
 - Clear indication by yellow coloured flag (2 Pole, 2 Module); indication through knob in others (2 Pole, 2 Module); indication through knob in others
 - Easy detection of occurrence of earth leakage

Flexibility

- **Flexibility In Termination**
 - For Compact 2 Pole 2 Mod RCBOs, bi-connect terminals offer busbar or cable termination at both incoming and outgoing sides
- **Line-load Reversibility**
 - For compact 2 Pole 2 Mod RCBOs, either of the sides of the RCBO can be used to terminate supply or load
 - For other RCBO variants, MCB side is recommended as incoming and RCD side as outgoing, ensuring backup protection to RCD section
- **RCBOs Removability with Busbar in Place**
 - This feature, with uniquely designed DIN clip, offers easy removal of DIN-mounted RCBOs while connection busbar is in place with adjoining devices
 - Reduces installation time



Reliability at every touch-point

Higher Reliability



Ensures Safe Installation

- **Safety Shutter**
 - Avoids incorrect cable insertion



True Position Indication

- Position of a knob indicates actual position of the contacts inside, ensuring customer safety



Prevents Unauthorized Access

- **Provision for Padlock**
 - Can be used either in ON or OFF position to meet specific customer requirements

Trip-free Mechanism

- Ensures reliable and safe product functioning



MCB
Overload + Short-circuit
Protection

+



RCB
Earth Leakage
Protection

=



RCBO
Overload + Short-circuit + Earth Leakage
= 3-in-1 Protection



Range Highlights

- Conforms to IEC 61009-1, IS12640-2, EN 61009-1
- Available in
 - Type AC – For standard installations
 - Type Adi – For installations with presence of pulsating DC along with transients and harmonics
- Wide range of current ratings – 6A to 63A
- Precise sensitivities for a variety of applications – from 10mA to 300mA
- 2P & 4P versions
- Suitable for Isolation
- Protection Degree - IP 20
- Availability of wide range of site-mountable accessories

Product Specifications

| ELECTRICAL | |
|---|-----------|
| Rated Operational Voltage | 240/415V |
| Rated Insulation Voltage | 500V |
| Rated Impulse Voltage | 6kV |
| Rated Frequency | 50Hz/60Hz |
| Rated Short-circuit Breaking Capacity, AC-6A to 63A IEC/EN 60898-1 | 10kA |
| Electrical Life (Operating Cycles) | 10,000 |

| MECHANICAL | |
|---|--|
| Mechanical Life (Operating Cycles) | 20,000 |
| Vibration Resistance (in X, Y, Z direction) | 1.5g, 30min, 5-80Hz |
| Shock Resistance (in X, Y, Z direction) | 10g, 3 Shocks, with short duration of 10ms |

| GENERAL | |
|-----------------------|---|
| Operating Temperature | AC Type: -25°C to +60°C Adi Type: -25°C to +60°C |

| INSTALLATION | |
|-------------------|---|
| Pollution Degree | 3 |
| Terminal Capacity | 35 mm ² (rigid) 25 mm ² (flexible) } up to 63A |
| Tightening Torque | 4Nm |
| Mounting Position | Horizontal / Vertical / Flat |

Decoding Product CAT Nos: AU-O

| | |
|------------------------|---|
| Range | AU |
| Standard | F Standard, C Curve |
| Calibration | 3 30 deg 4 40 deg 5 50 deg |
| Type | C AC D Adi |
| Number of Poles | 2 2 Pole 4 4 Pole |
| Rating (A) | 006 6A 010 10A 016 16A 020 20A 025 25A 032 32A 040 40A 050 50A 063 63A |
| Sensitivity | 01 10mA 03 30mA 10 100mA 30 300mA |

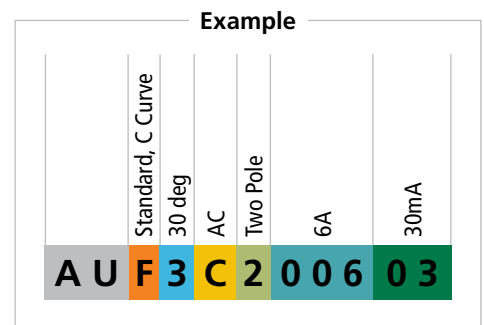



Product Range: AU-O, AU-F

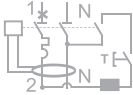

| Description | Rating | Module | 10mA | 30mA | 100mA | 300mA |
|---|--------|--------|-------------|-------------|-------------|-------------|
| Type AC 2P   | 6A | 2 | AUF3C200601 | AUF3C200603 | AUF3C200610 | AUF3C200630 |
| | 10A | 2 | AUF3C201001 | AUF3C201003 | AUF3C201010 | AUF3C201030 |
| | 16A | 2 | - | AUF3C201603 | AUF3C201610 | AUF3C201630 |
| | 20A | 2 | - | AUF3C202003 | AUF3C202010 | AUF3C202030 |
| | 25A | 2 | - | AUF3C202503 | AUF3C202510 | AUF3C202530 |
| | 32A | 2 | - | AUF3C203203 | AUF3C203210 | AUF3C203230 |
| | 40A | 2 | - | AUF3C204003 | AUF3C204010 | AUF3C204030 |
| | 63A | 4 | - | AUF3C206303 | AUF3C206310 | AUF3C206330 |

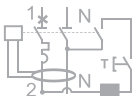

| | | | | | | |
|--|-----|---|---|-------------|-------------|-------------|
| Type Adi 2P   | 6A | 2 | - | AUF3D200603 | AUF3D200610 | AUF3D200630 |
| | 10A | 2 | - | AUF3D201003 | AUF3D201010 | AUF3D201030 |
| | 16A | 2 | - | AUF3D201603 | AUF3D201610 | AUF3D201630 |
| | 20A | 2 | - | AUF3D202003 | AUF3D202010 | AUF3D202030 |
| | 25A | 2 | - | AUF3D202503 | AUF3D202510 | AUF3D202530 |
| | 32A | 2 | - | AUF3D203203 | AUF3D203210 | AUF3D203230 |
| | 40A | 2 | - | AUF3D204003 | AUF3D204010 | AUF3D204030 |

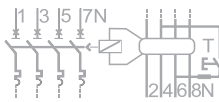

| Description | Rating | Module | 10mA | 30mA | 100mA | 300mA |
|---|--------|--------|------|-------------|-------------|-------------|
| Type AC 4P   | 16A | 7.5 | - | AUF3C401603 | AUF3C401610 | AUF3C401630 |
| | 20A | 7.5 | - | AUF3C402003 | AUF3C402010 | AUF3C402030 |
| | 25A | 7.5 | - | AUF3C402503 | AUF3C402510 | AUF3C402530 |
| | 32A | 7.5 | - | AUF3C403203 | AUF3C403210 | AUF3C403230 |
| | 40A | 7.5 | - | AUF3C404003 | AUF3C404010 | AUF3C404030 |
| | 63A | 7.5 | - | AUF3C406303 | AUF3C406310 | AUF3C406330 |

Dimension Details – RCBO 2P in 2 Mod.

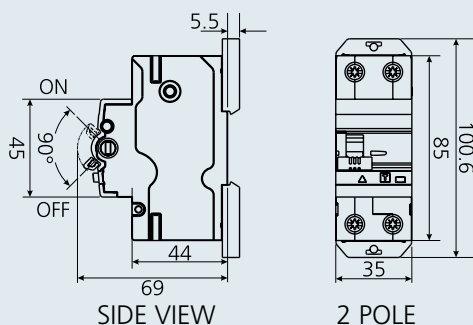

Dimension Details – RCBO

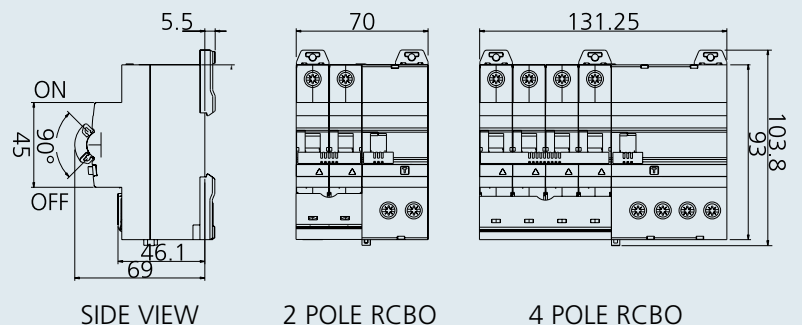



SPDs - Safety against surges

SPDs provide protection to electrical/electronic equipment against a brief overvoltage spike or disturbance on a power/signal waveform called a surge. The AU Solutions range of SPDs provides protection against lightning and switching surges.

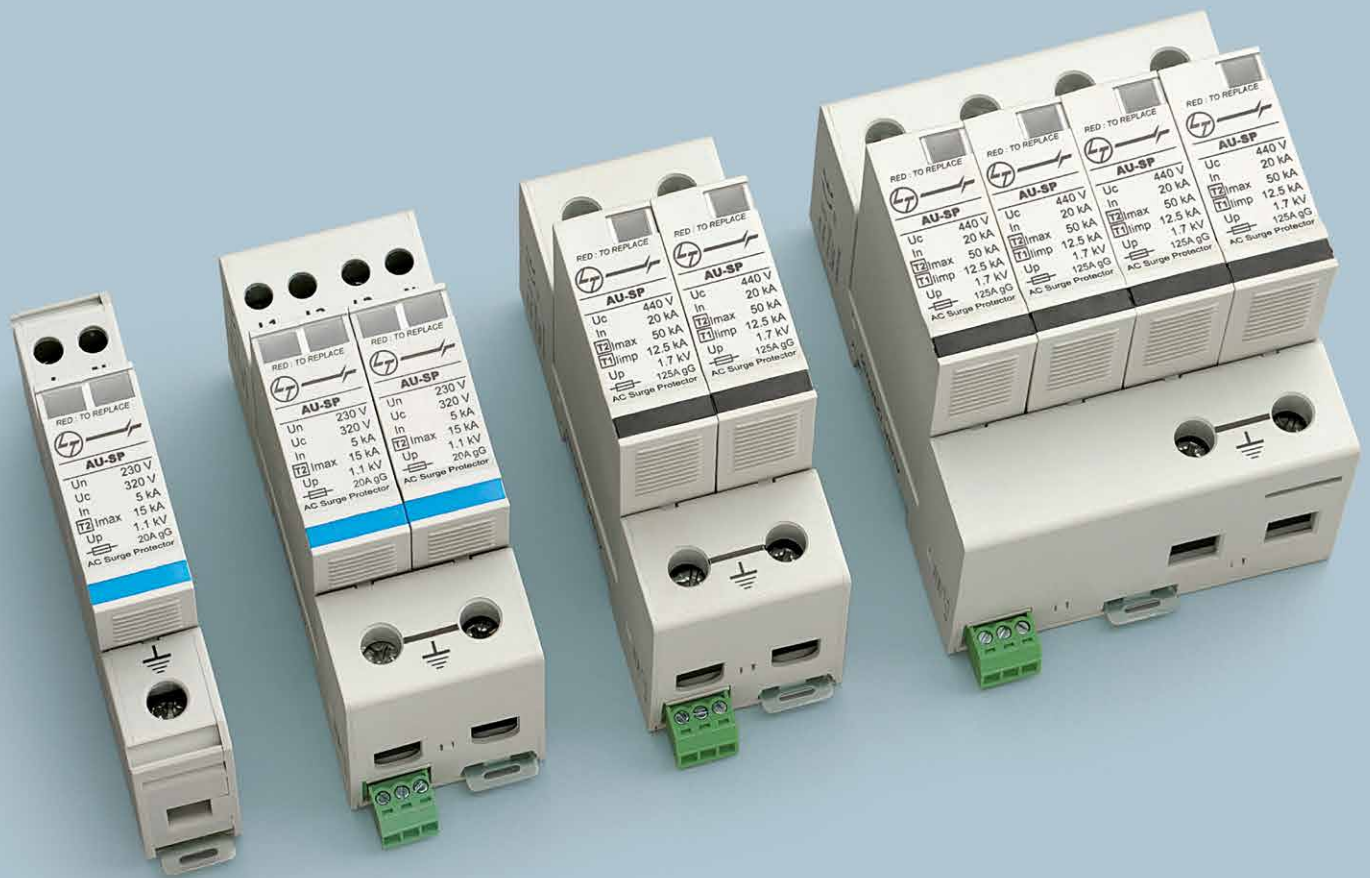

AU-SP Range of SPDs



Protects sensitive equipment,
minimizes costly downtime



Long-lasting, Easy to Use

- Pluggable module for each phase
- Easy replacement of individual phase cartridges



Remote Signaling

- Indicates SPD OK
- Indicates disconnected on account of a surge



Compact, Space Saving

- Type 2* 1P+N in one module
- Type 2* 3P+N in two modules

Range Highlights

- Conforms to IEC 61643-11
- Available in Type 2 and Type 1+2
- Type 2 : Protection against indirect lightning and switching surges
 - Maximum Discharge Current – I_{max} up to 70kA
- Type 1+2 : Protection against direct and indirect lightning surges
 - Maximum Discharge Current – I_{max} up to 100kA

T*Type 2 SPDs with I_{max} 40kA & 15kA



Product Specifications

| | Type 1+2 SPDs | | | |
|--|------------------------------|-----------------------|--------------------------|-----------------------|
| | AUSP 121PN50 | AUSP 123PN50 | AUSP 121PN100 | AUSP 123PN100 |
| Operating voltage | 230/400V | | | |
| Maximum Operating Voltage U_c | 440 V AC | | | |
| TOV/withstand U_T | 770 V AC | | | |
| Operating Current I_c | <1 mA | | | |
| Nominal Discharge Current I_n 15X 8/20 micro second | 20kA | | | 30kA |
| Maximum Discharge Current I_{max} Maximum withstand 8/20 micro second | 50kA | | | 100kA |
| Max. lightning Current by Pole I_{imp} Max withstand at 10/350 micro second | 12.5kA | | | 8kA |
| Protection Level U_p | 1.7kV | | | 1.8kV |
| Admissible Short Circuit Current | 25000A | | | |
| Back up Fuses | Fuses type gG - 125A max | | Fuses type gG - 100A max | |
| Terminal Capacity | 2.5 - 25 mm ² | | | |
| Disconnection Indicator (per pole) | 1 Mechanical Indicator | | 2 Mechanical Indicator | |
| Remote Signalling | Output on changeover contact | | | |
| Operating Temperature | -40°C to 85°C | | | |
| Protection Degree | IP 20 | | | |
| Dimension (HxWxD) | 90 mm x 36 mm x 67 mm | 90 mm x 72 mm x 67 mm | 90 mm x 36 mm x 67 mm | 90 mm x 72 mm x 67 mm |

| | Type 2 SPDs | | | | | |
|--|--|-----------------------|------------------------|-----------------------|--------------------------|-----------------------|
| | AUSP021PN40 | AUSP023PN40 | AUSP021PN15 | AUSP023PN15 | AUSP021PN70 | AUSP023PN70 |
| Operating voltage | 230V/400V | | | | | |
| Maximum Operating Voltage U_c | 320 V AC | | | | | |
| TOV/withstand U_T | 770 V AC | | | | 335 V AC | |
| Operating Current I_c | <1 mA | | | | | |
| Nominal Discharge Current I_n 15 x 8/20 micro second | 20kA | | 5kA | | | 30kA |
| Maximum Discharge Current I_{max} Maximum withstand 8/20 micro second | 40kA | | 15kA | | | 70kA |
| Protection Level U_p | 1.5 kV | | 1.1 kV | | | 1.6 kV |
| Admissible Short Circuit Current | 10000A | | | | 25000A | |
| Back up Fuses | Fuse type gG - 50A max | | Fuse type gG - 25A max | | Fuse type gG - 100A max | |
| Terminal Capacity | L/N 1.5 - 10 mm ² and PE 2.5 - 25 mm ² | | | | 2.5 - 25 mm ² | |
| Disconnection Indicator (per pole) | 2 Mechanical Indicators | | | | | |
| Remote Signalling | Output on changeover contact | | | | | |
| Operating Temperature | -40°C to 85°C | | | | | |
| Protection Degree | IP 20 | | | | | |
| Dimension (HxWxD) | 90 mm x 18 mm x 67 mm | 90 mm x 36 mm x 67 mm | 90 mm x 18 mm x 67 mm | 90 mm x 36 mm x 67 mm | 90 mm x 36 mm x 67 mm | 90 mm x 72 mm x 67 mm |





Decoding Product Cat. Nos.: AU-SP

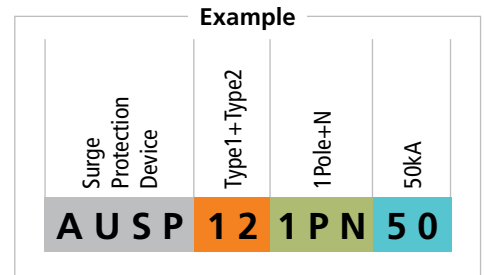

| | | | | |
|------------------------|------------------|--------------------|----------------|--|
| SPD | AU SP | | | |
| Type | 02 Type 2 | 12 Type 1+2 | | |
| Number of Poles | 1PN | 3PN | | |
| | 1 P+N | 3 P+N | | |
| Rating (kA) | 15 15kA | 50 50kA | 40 40kA | |
| | 70 70kA | 100 100kA | | |



Product Range: AU-SP

| Description | Configuration | Modules | Cat. Nos. |
|---|---------------|---------|--------------|
|  Type 1+2, I _{max} 50kA | 1P+N | 2 | AUSP 121PN50 |
| | 3P+N | 4 | AUSP 123PN50 |
| | 1P+N | 2 | AUSP121PN100 |
| | 3P+N | 4 | AUSP123PN100 |
|  Type 2, I _{max} 40kA | 1P+N | 1 | AUSP 021PN40 |
| | 3P+N | 2 | AUSP 023PN40 |
| | 1P+N | 2 | AUSP021PN70 |
| | 3P+N | 4 | AUSP023PN70 |
|  Type 2, I _{max} 15kA | 1P+N | 1 | AUSP 021PN15 |
| | 3P+N | 2 | AUSP 023PN15 |

SPD Back-up Protection Details

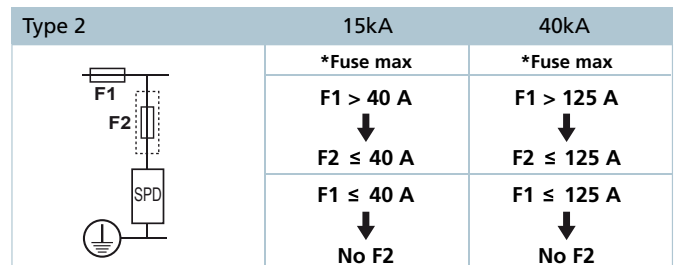
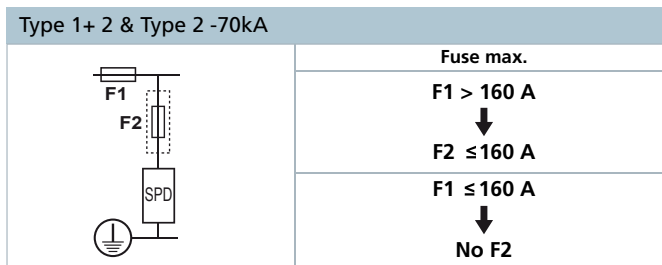



MONITORING DEVICES

The AU Solutions range of protection devices are complemented by a host of monitoring devices.

Accessories

- Auxiliary Contact (AUX)
- Auxiliary / Trip Alarm Contact (AUX/TAC)
- Undervoltage Release (UV)
- Overvoltage Release (OV)
- Shunt Release (SR)
- Padlocks

Energy Meters

- Single-phase
- Three-phase

Indicating Lights

- For single-phase and three-phase supply





Accessories - The freedom to choose

With the AU Solutions range, you can select from a common set of accessories for RCCBs, RCBOs, MCBs and Isolators.

- Auxiliary Contact (AUX)
- Auxiliary / Trip Alarm Contact (AUX/TAC)
- Undervoltage Release (UV)
- Overvoltage Release (OV)
- Shunt Release (SR)
- Padlocks

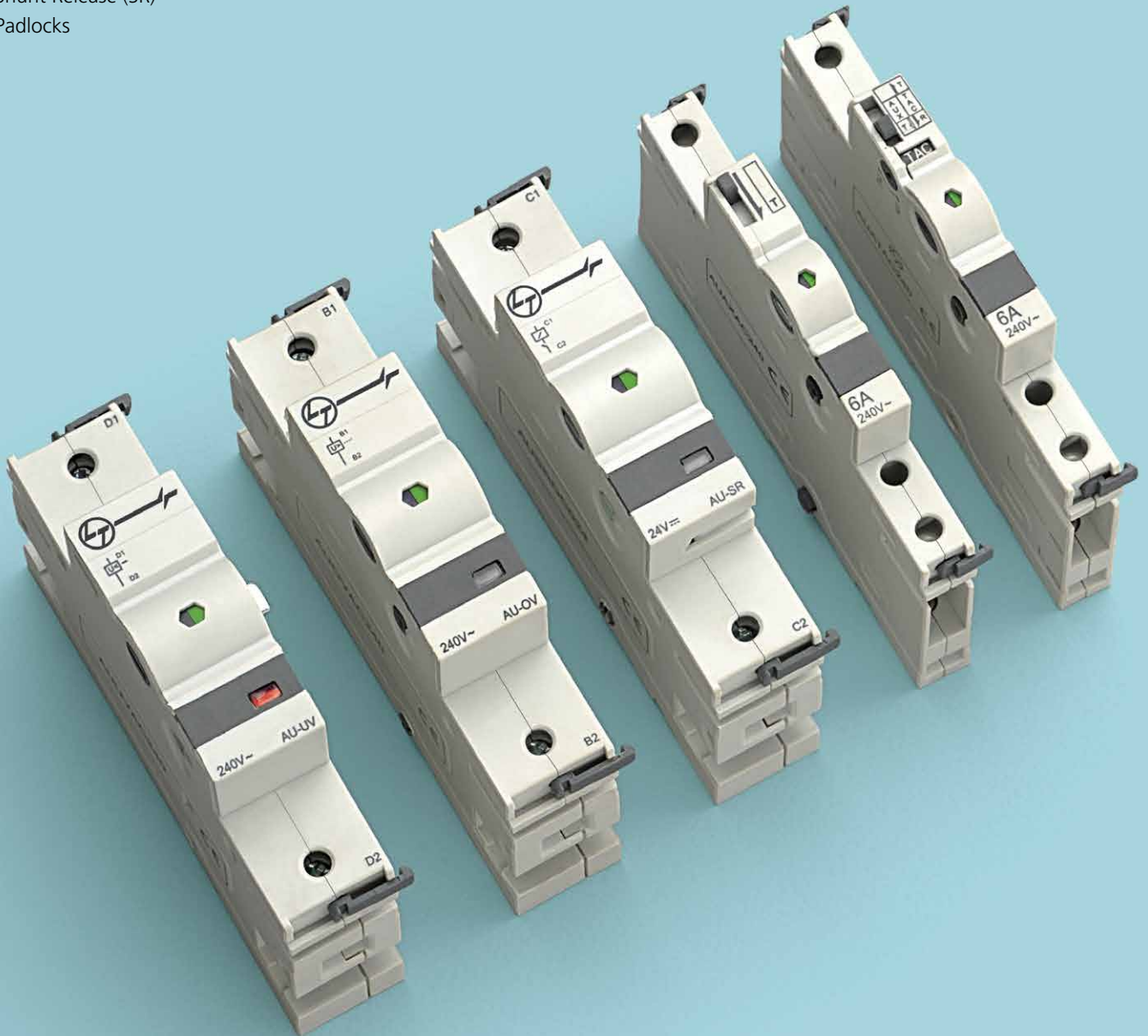



A common set of accessories, with uncommon benefits

The AU Solutions range of accessories is designed to complement AU MCBs, RCCBs, RCBOs and Isolators.

Increased Flexibility

One Mod = 17.5mm
Half Mod = 8.75mm



Mounting on the Left Side

- The left side of the MCB, RCCB, RCBO and Isolator has a provision to mount Half Mod and One Mod accessories

Mounting Sequence for Multiple Accessories

- In Half Module Accessories, TAC should be located next to the main device

Mounting for up to 3 Accessories

- 3 Half Mod or 3 One Mod or a combination of both
- All accessories to be stacked on the left side

Enhanced Convenience

• Half Mod Accessories (AU-AX, AU-AT)



Test Button

- Check product functioning without operating the main device

Reset Button

- Available in AU-AT
- Helps to manually acknowledge the actuation of an accessory without affecting the status of the main device

Auxiliary Contact or Trip Alarm Contact

- As per customer requirement
- Flexibility of selection of either AUX or TAC

Actuator:

- When connected in **AUX mode** to main device (main device in OFF condition), actuator in 'UP' position
- When connected in **TAC mode** to main device (main device in OFF condition), actuator in 'DOWN' position

Test for TAC:

- With the accessory in TAC mode, changeover of NO/NC contacts can be checked by moving the actuator to this position

Reset for TAC:

- With the accessory in TAC mode, when the breaker trips, TAC can be reset by moving the actuator to this position

Test For AUX:

- With the accessory in AUX mode, changeover of NO/NC contacts can be checked by moving the actuator to this position



• One Mod Accessories (AU-UV, AU-OV, AU-SR)

- Flag Indicator for 'undervoltage', 'overvoltage' and 'remote-tripping'
- OV, UV: Unique design that prevents reclosing of the associated protection device until the voltage resumes the normal threshold



Range Highlights

- Standard compliance
 - Undervoltage Release – IEC 60947-1
 - Shunt Release – IEC 60947-1
- Protection Degree – IP 20
- Auxiliary Contact (AU-AX) & Selectable Auxiliary/Trip Alarm Contact (AU-AT) are offered in Half Module
- Undervoltage (AU-UV), Overvoltage (AU-OV) and Shunt Release (AU-SR) are offered in One Module
- All Half Module and One Module Accessories are common for MCBs and RCDs
- Padlock is offered in two versions
 - AUPD 01 – suitable for 1Pole = 1 Module Devices
 - AUPD 02 – suitable for 1Pole = 1.5 Module Devices

Product Specifications



| Electrical | | | | |
|------------------------------------|-----------------|------------------|-----------------|--|
| | AU-AX, AU-AT | AU-OV | AU-SR | AU-UV |
| | AUX; AUX/TAC | Overvoltage | Shunt Release | Undervoltage Release |
| Rated Current | 6A | | | |
| Rated Operational Voltage | 240V AC, 24V DC | 240V AC | 240V AC, 24V DC | |
| Rated Impulse Voltage | 4kV | | | |
| Rated Frequency | 50/60 Hz | | | |
| Electrical Life (Operating Cycles) | 10,000 | | | |
| Pick-up Voltage | - | - | - | 85% of rated operational Voltage |
| Drop-off voltage | - | - | - | Between 70% and 35% of Rated Operational Voltage |
| Trip Threshold Voltage | - | 265-280 V AC | - | - |
| Continuous Consumption | - | Less than 0.9 VA | - | Less than 3VA (for 240V AC) |

| Installation | | | | |
|-------------------|--------------|-------|-------|-------|
| | AU-AX, AU-AT | AU-OV | AU-SR | AU-UV |
| Terminal Capacity | 2.5 sq mm | | | |

| General | | | | |
|-----------------------|---------------|-------|-------|-------|
| | AU-AX, AU-AT | AU-OV | AU-SR | AU-UV |
| Utilization Category | AC 12 | - | - | - |
| Contact Configuration | 1NO + 1NC | - | - | - |
| Operating Temperature | -25°C to 60°C | | | |







Decoding Product CAT Nos.:
AU-UV, AU-OV, AU-SR, AU-AX, AU-AT

| | | | |
|--------------------|------------------------------|-----------------------------|-------------------------------|
| Accessories | AU-UV Undervoltage | AU-OV Overvoltage | AU-SR Shunt Release |
| | AU-AX Aux Contact | AU-AT Aux/TAC | |
| AC/DC | AC AC | DC DC | |
| | 240 240V | 24 24V | |



Example

| | | |
|-----------|-------|-------|
| Accessory | AC/DC | 240V |
| A U U V | A C | 2 4 0 |

Product Range: AU-AX, AU-AT, AU-UV, AU-OV, AU-SR; AU-PD

| Description | Configuration | Module | Voltage | Cat. Nos. |
|--|--------------------|------------|------------------------------------|---------------------------|
|  <p>Auxiliary Contact</p> <pre> 13 21 14 22 </pre> | 1NO+1NC | 0.5 | 240V AC, 24V DC | AUAX AC240 |
|  <p>AUX/TAC</p> <pre> 13/93 21/91 14/94 22/92 </pre> | 1NO+1NC 1NO+1NC | 0.5 0.5 | 240V AC, 24V DC 240V AC, 24V DC | AUAT AC240 AUATAC240HR |
|  <p>Undervoltage Release</p> <pre> D1 < D2 </pre> | - - | 1 1 | 240V AC 24V DC | AUUV AC240 AUUV DC024 |
|  <p>Overvoltage Release</p> <pre> B1 > B2 </pre> | - | 1 | 240V AC | AUOV AC240 |



| Description | Configuration | Module | Voltage | Cat. Nos. |
|--|---------------|--------|---------|------------|
|  <p>Shunt Release</p>  | - | 1 | 240V AC | AUSR AC240 |
| | - | 1 | 24V DC | AUSR DC024 |

| | | |
|---|---|--------|
|  <p>Padlock - Suitable for Lock Hasp 3.5 - 5 mm dia. max</p> | Suitable for 1 Pole = 1 Mod devices: MCBs up to 63A, RCCBs, RCBOs, Isolators, Changeover Switches up to 40A | AUPD01 |
| | Suitable for 1 Pole - 1.5 Mod devices: MCBs 80A-125A, Changeover Switch 63A | AUPD02 |

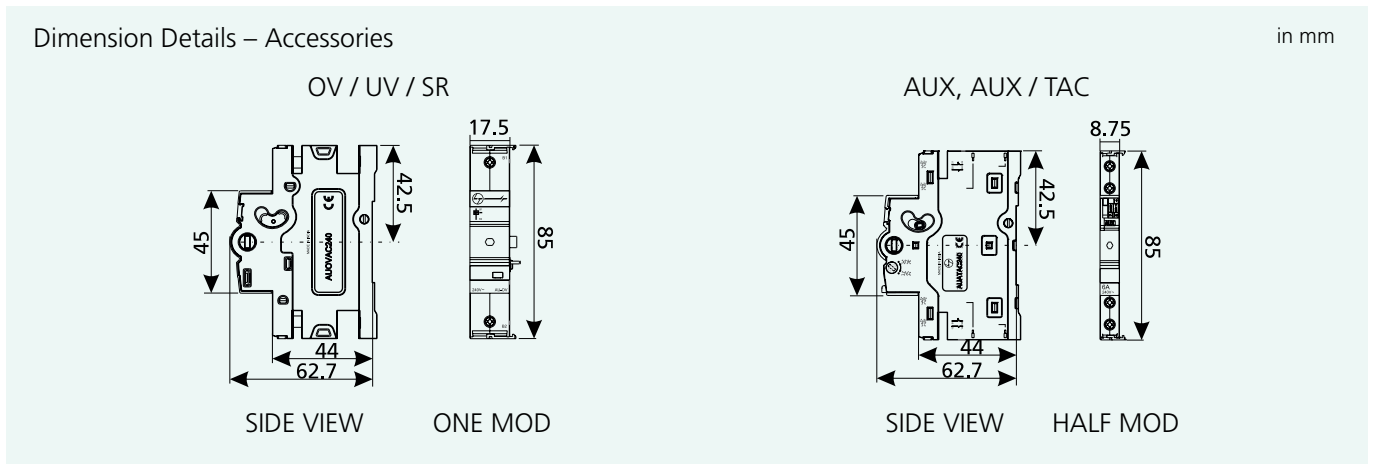



Mounting of Accessories

Termination

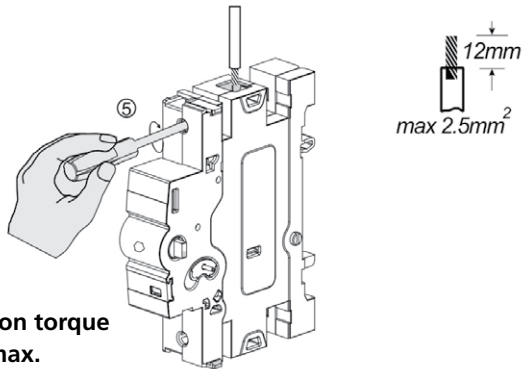

Termination torque
0.5 N-m max.

Mounting

►MATCH AND FIX THIS ALL 5 POINTS

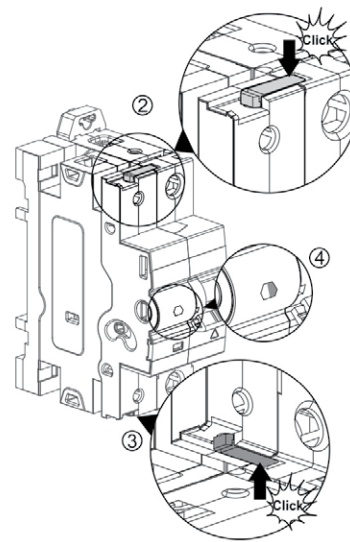
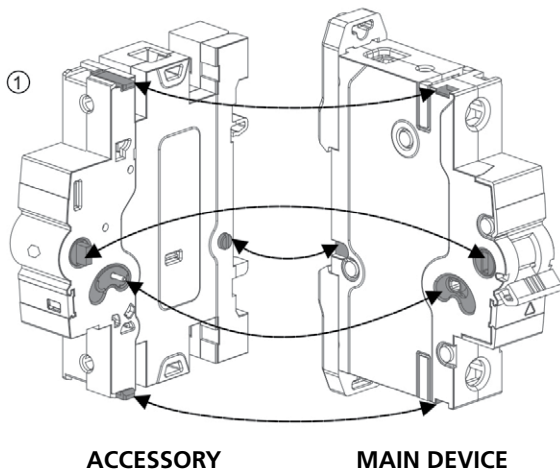

Accessory Fitment

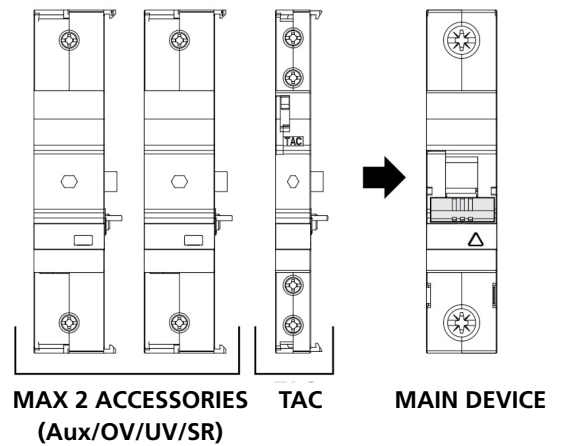
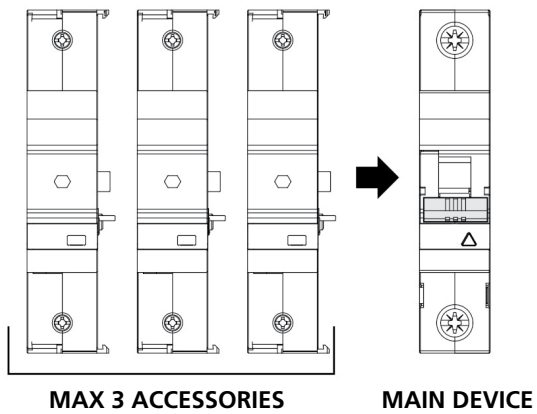

Note: 3 Accessories

- 3 Half Mod* or 3 One Mod or a combination of both
- Any Combination of OV or UV or Aux or Aux/TAC (Aux mode)

* For RCCB 2 Half Mod

Note:

- TAC always first



Energy Meters - that talk

The AU Solutions range of Energy Meters is ahead of its time, meeting your need for energy management.





Intelligent and convenient

Energy Meters, available in single-phase and three-phase versions, can be mounted on a DIN rail to monitor power consumption of identified loads, circuits and areas.

Easy Reading

- LCD display
- Displays day, week, month and push-to-push kWh consumption

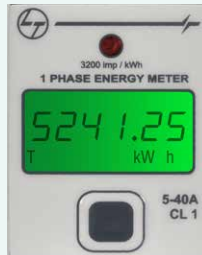

Comfortable Operation

- Pushbutton for parameter scrolling

Effortless mounting

- Compact size, easy DIN rail mounting

Range Highlights

- Communication with the help of RS 485 & WiFi module
- Class 1 accuracy
- Direct current operated meter
- Reverse current indication for three-phase meter

Product Specifications

| Parameters | | Display Parameters | |
|---------------------------------|----------------|--------------------|---------------|
| | | 3-Phase meter | 1-Phase meter |
| Instantaneous Parameters | Phase voltage | ✓ | ✓ |
| | Phase current | ✓ | ✓ |
| | Power factor | ✓ | - |
| | Active power | ✓ | ✓ |
| | Reactive power | ✓ | - |
| | Apparent power | ✓ | - |
| | Frequency | ✓ | - |
| Maximum Demand | Present month | ✓ | - |
| | Previous month | ✓ | - |
| kWh Consumption | Total | ✓ | ✓ |
| | Present day | ✓ | ✓ |
| | Present week | ✓ | ✓ |
| | Present month | ✓ | ✓ |
| | Push-to-push | ✓ | ✓ |
| | Previous day | ✓ | ✓ |
| | Previous week | ✓ | ✓ |
| Previous month | ✓ | ✓ | |



Product Specifications

| GENERAL | | |
|-------------------|-------------------------------------|--|
| Display | Type | 6 digit LCD |
| | Height | 6 mm (10mm in case of 3Phase meter) |
| Measuring Circuit | Class of accuracy | Class 1 as per IEC 62053-21 |
| | Measurement circuit burden | <1W, <8VA |
| | Rated Voltage | 240 V |
| | Current | 3 phase: 10-60A 1 phase: 5-40A |
| | Starting current | 3 phase: 40mA 1 phase: 20mA |
| | Voltage range for class of accuracy | -30% to +20% of rated voltage |
| | Current range for class of accuracy | 5% I _b to I _{max} |
| | Input frequency range | 50Hz ±5% |
| Dimensions | Weight | 3 phase: 460g (approx.) 1 phase: 150g (approx.) |

Product Range: AU-EM

| Description | Module | Cat. Nos. |
|--|--------|--------------|
|  Single Phase Three Phase | 2 | WD4000101000 |
| | 7 | WD4000103000 |

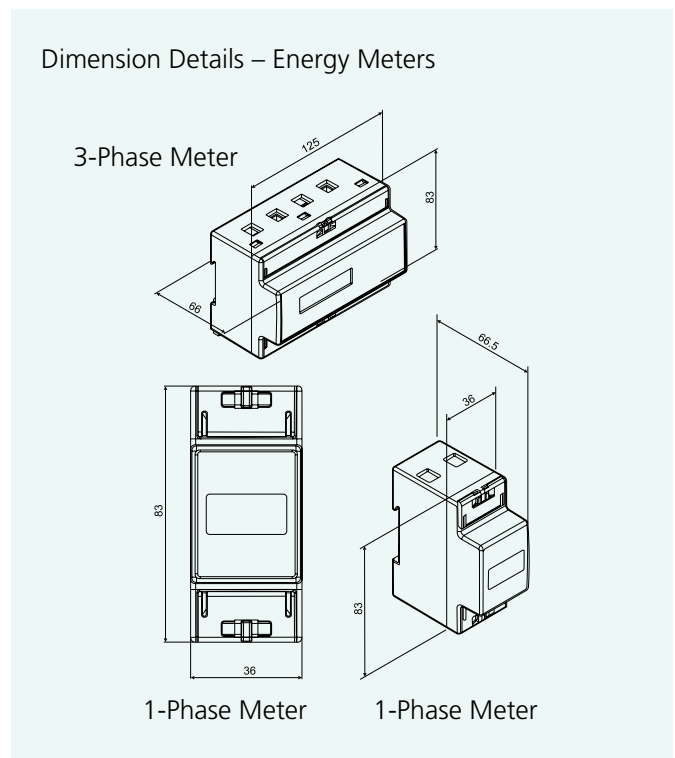
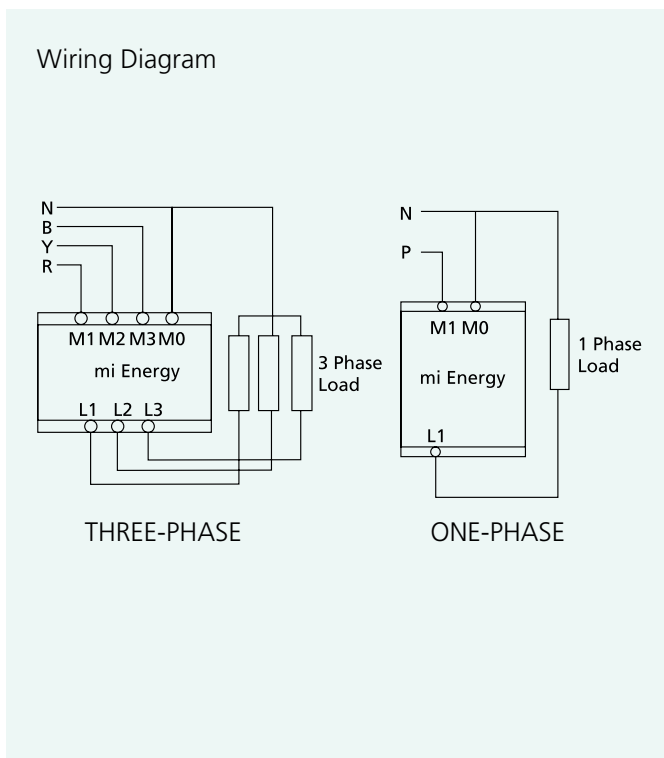



Indicating Lights - Longer life, higher savings

The AU Solutions range of indicating lights uses LED technology, known for its low power consumption. Indicating lights show the status of the supply in the electrical system.

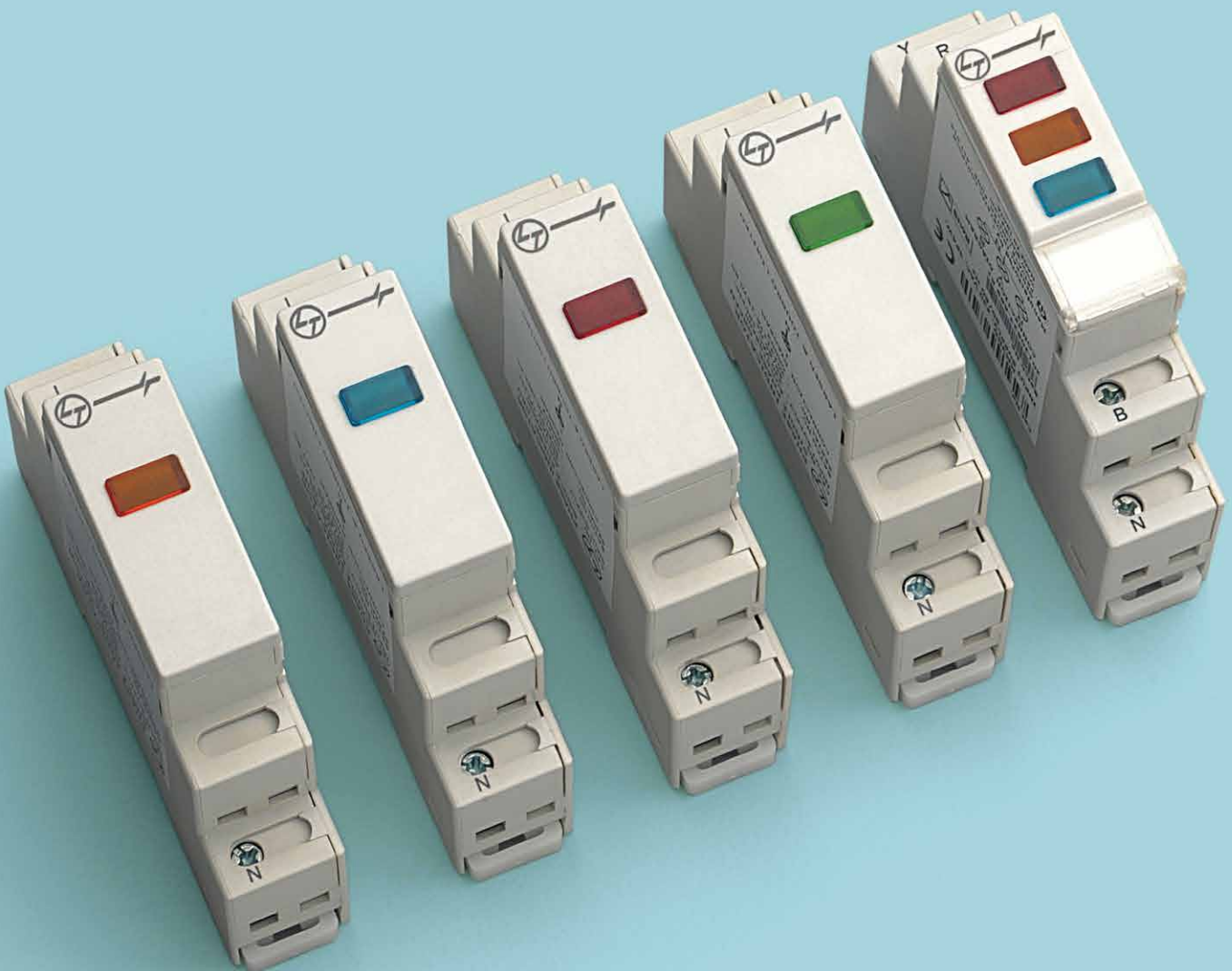



Convenient and efficient

- LED technology
- Modular design, suitable for DIN rail mounting
- Available in RED, YELLOW, BLUE and GREEN
- Three-in-one Indication R-Y-B in One Module



Product Specifications

| GENERAL | |
|---------------------------|----------------|
| Rated Operational Voltage | 240V AC |
| Power Consumption | 1.8W |
| Rated Frequency | 50/60Hz |
| Operating Temperature | -10°C to +55°C |
| Ingress Protection | IP 20 |

Decoding Product CAT Nos.: AU-IL

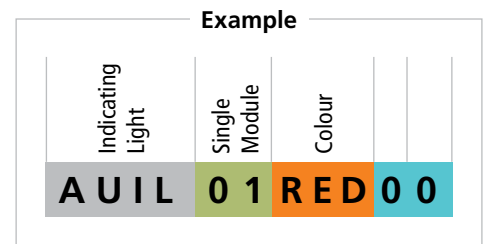
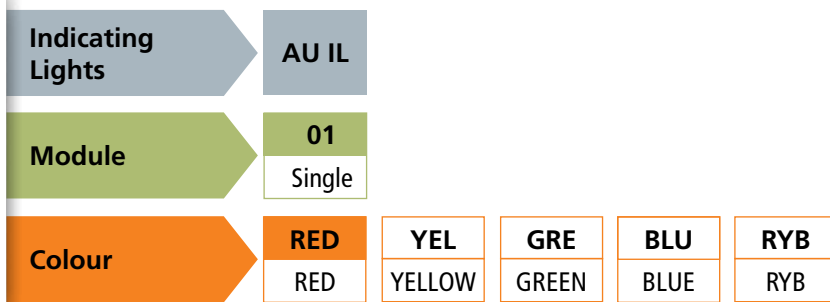

Product Range: AU-IL

| Description | Modules | Cat. Nos. |
|-----------------|---------|--------------|
| RED | 1 | AUIL 01RED00 |
| YELLOW | 1 | AUIL 01YEL00 |
| BLUE | 1 | AUIL 01BLU00 |
| GREEN | 1 | AUIL 01GRE00 |
| RED-YELLOW-BLUE | 1 | AUIL 01RYB00 |



Dimension Details – Indicating Lights

in mm

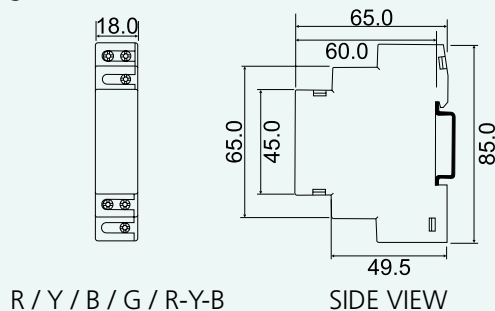



CONTROL DEVICES

The AU Solutions range includes a host of Control Devices.

Isolators

- 25A to 125A
- DP, TP and FP

Modular Contactors

- 25A to 63A
- SP, DP, TP and FP

Changeover Switches

- 25A to 63A
- DP and FP

Time Switches

- Digital
- Analog
- Astronomical

ACCL

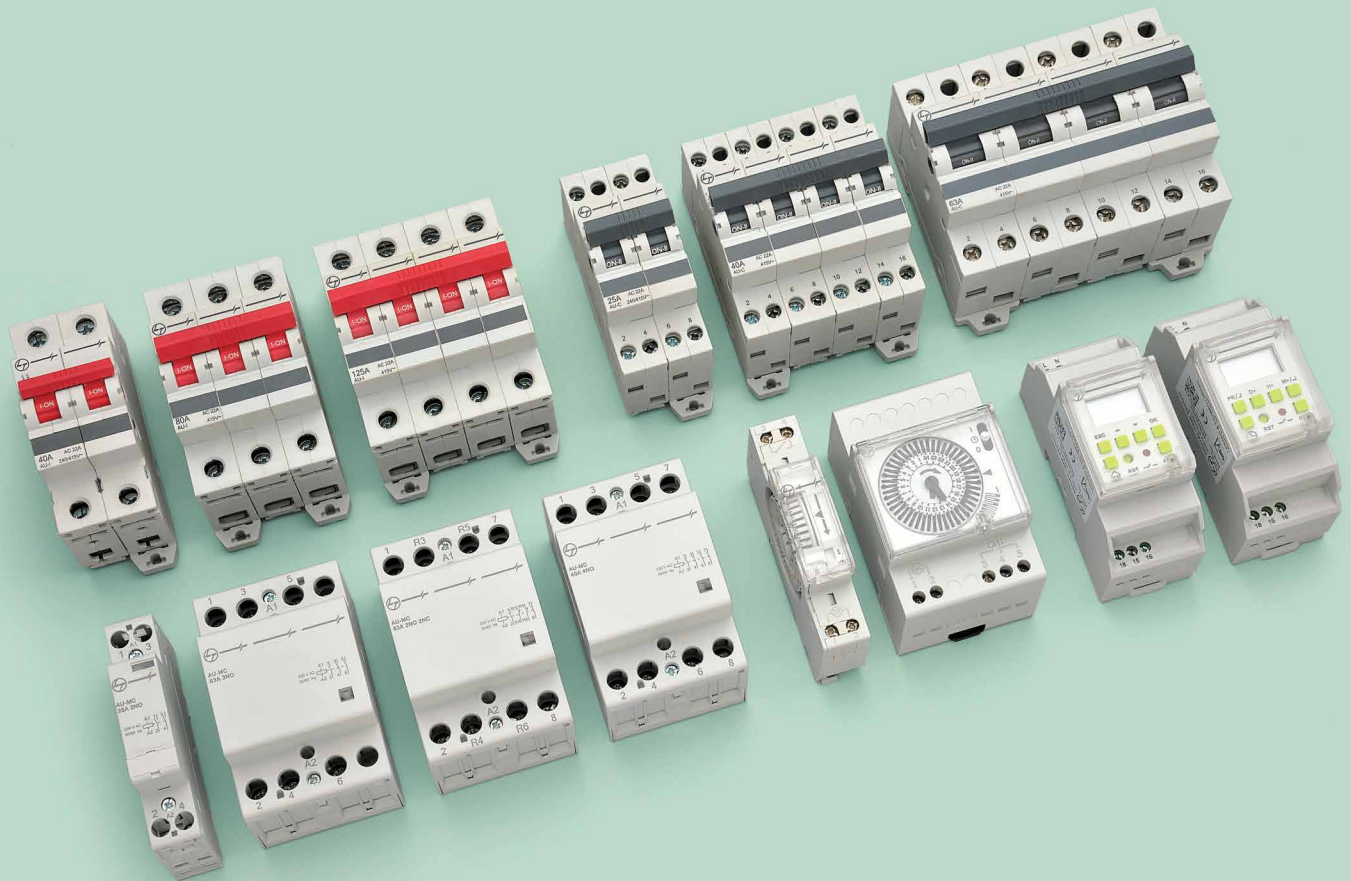



Isolators - Operational safety, downstream

Isolators are typically used for a switching function and to provide isolation in electrical circuits. The AU Solutions range of isolators is available from 25A to 125A in 2P, 3P and 4P versions.

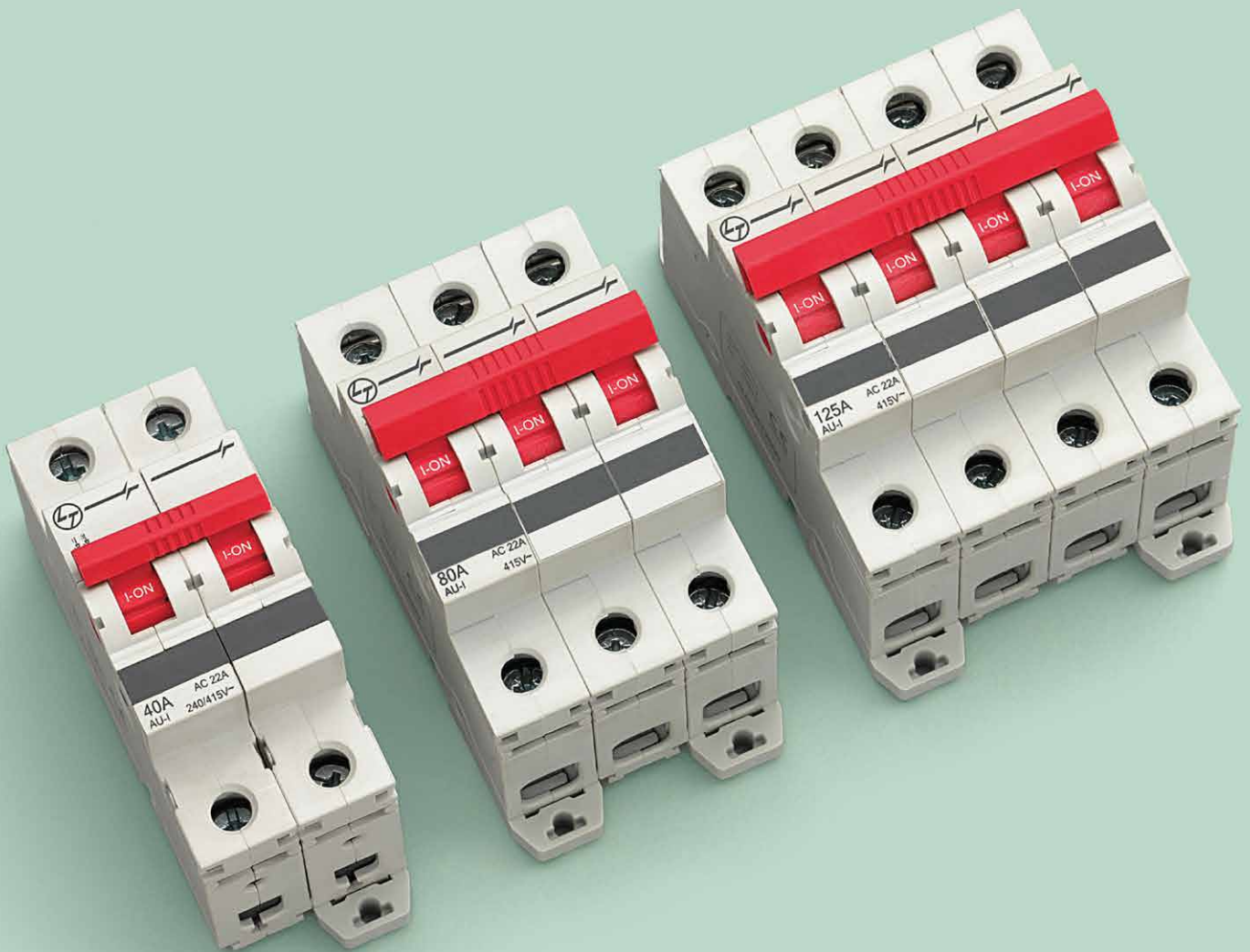



Optimum convenience, maximum safety

| | | |
|---|---|---|
| | | |
| <p>Prevents Unauthorized Access</p> <ul style="list-style-type: none"> • Provision for Padlock <ul style="list-style-type: none"> - Can be used either in ON or OFF position | <p>Ensures Safe Installation</p> <ul style="list-style-type: none"> • Safety Shutter <ul style="list-style-type: none"> - Avoids incorrect cable insertion | <p>Convenience</p> <ul style="list-style-type: none"> - Suitable for standard and cross-head (Phillips) screwdriver |

Range Highlights

- Suitable for Isolation as per IEC 60947-3, IS/IEC 60947-3
 - providing operational safety downstream
- Comprehensive range – suitable for various applications
- Utilization Category of AC-22A
- Suitability for mounting Auxiliary Contacts

Product Specifications

| ELECTRICAL | |
|------------------------------------|--|
| Rated Operational Voltage | 240/415V |
| Rated Frequency | 50Hz/60Hz |
| Utilization Category | AC-22A |
| Rated Insulation Voltage, | 500V |
| Rated Impulse withstand voltage | 6kV |
| Short Time Withstand, Icw | 20In for 1 sec |
| Short Circuit Making capacity, Icm | 20In |
| Electrical Life (Operating Cycles) | 20,000 up to 40A 15,000 63A 10,000 80A, 100A 2,500 125A |

| MECHANICAL | |
|------------------------------------|--------|
| Mechanical Life (Operating Cycles) | 20,000 |

| INSTALLATION | |
|-------------------|--|
| Terminal Capacity | 35 sq.mm (Rigid) } up to 63A 25 sq.mm (flexible) } 50 sq.mm (Rigid) } 80A to 125A 35 sq.mm (flexible) } |

| GENERAL | |
|-----------------------|----------------|
| Pollution Degree | 3 |
| Operating Temperature | -25°C to +60°C |
| Protection Degree | IP 20 |







Decoding Product CAT Nos.: AU-I

| | | | | | | | | | |
|------------------------|-------------|------------|------------|------------|------------|------------|------------|----------------|--|
| Isolator | AU I | | | | | | | Example | |
| Number of Poles | 2 | 3 | 4 | | | | | | |
| | 2-Pole | 3-Pole | 4-Pole | | | | | | |
| Rating (A) | 025 | 032 | 040 | 050 | 063 | 080 | 100 | 125 | |
| | 25A | 32A | 40A | 50A | 63A | 80A | 100A | 125A | |

| | | | | |
|--------------|-----------|-----------|------------|-----------|
| Isolator | | Four Pole | 125A | |
| A U I | 00 | 4 | 125 | 00 |

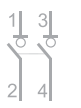
Product Range: AU-I

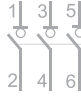

| Description | Rating | Modules | Cat Nos |
|--|--------|---------|--------------|
|  <p>Double Pole</p>  | 25A | 2 | AUI00 202500 |
| | 32A | 2 | AUI00 203200 |
| | 40A | 2 | AUI00 204000 |
| | 63A | 2 | AUI00 206300 |
| | 80A | 2 | AUI00 208000 |
| | 100A | 2 | AUI00 210000 |
|  <p>Three Pole</p>  | 125A | 2 | AUI00 212500 |
| | 32A | 3 | AUI00 303200 |
| | 40A | 3 | AUI00 304000 |
| | 63A | 3 | AUI00 306300 |
| | 80A | 3 | AUI00 308000 |
| | 100A | 3 | AUI00 310000 |
|  <p>Four Pole</p>  | 125A | 3 | AUI00 312500 |
| | 32A | 4 | AUI00 403200 |
| | 40A | 4 | AUI00 404000 |
| | 63A | 4 | AUI00 406300 |
| | 80A | 4 | AUI00 408000 |
| | 100A | 4 | AUI00 410000 |
| | 125A | 4 | AUI00 412500 |

Dimension Details – Isolators

in mm

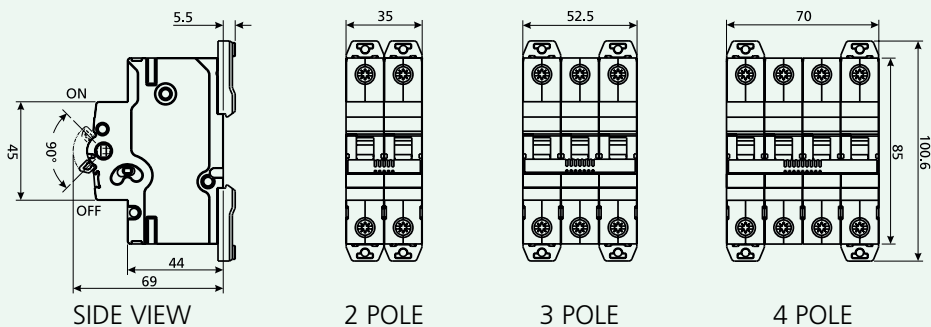



Changeover Switches - Change over to a secure power supply

If continuity of power is what you seek for your business, the AU Solutions range of manual Changeover Switches is the answer. The Changeover Switches perfectly suit your applications, having a range of up to 63A.

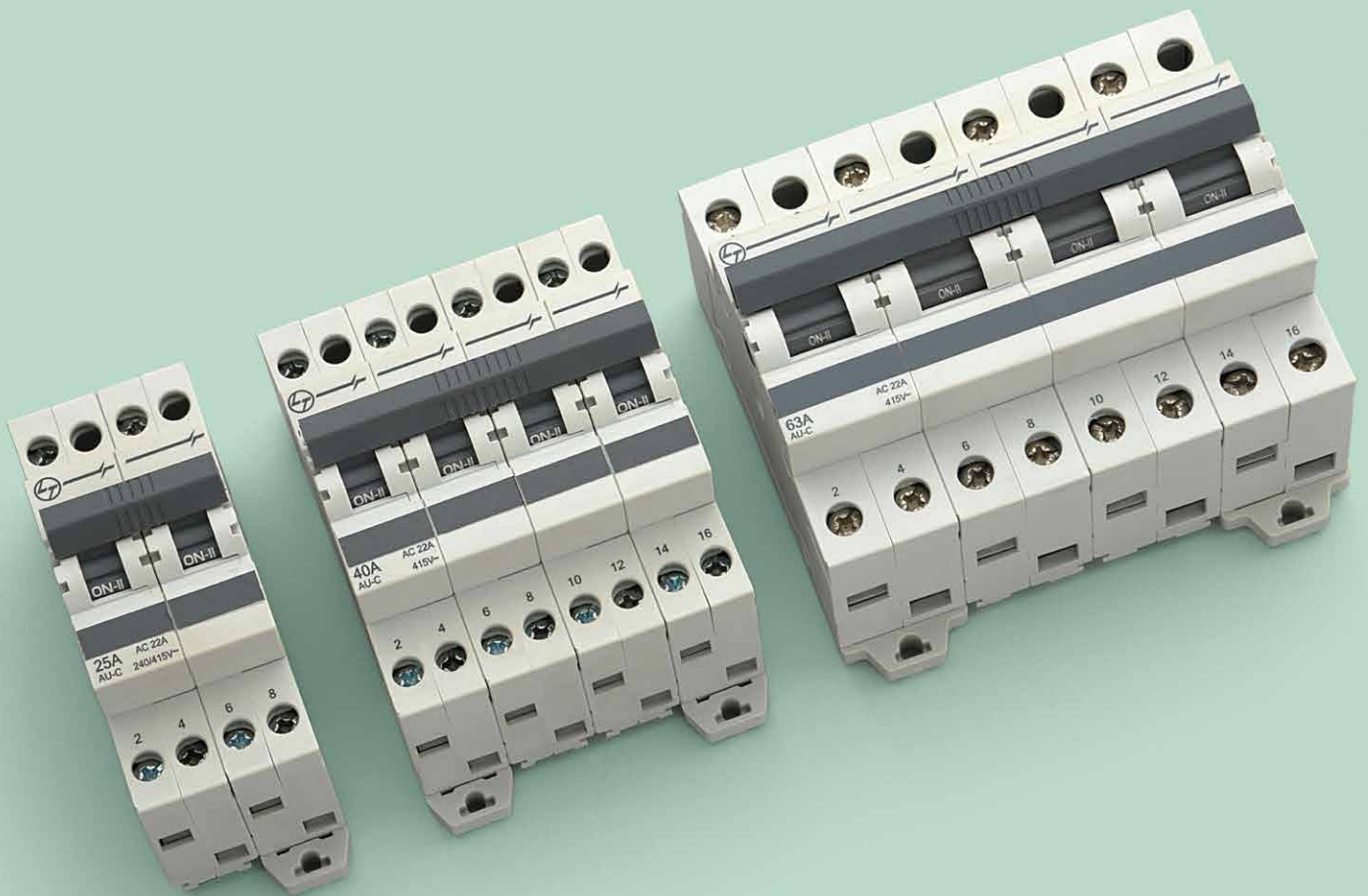



Assured Safety

The AU Solutions range of Changeover Switches provides the perfect solution for low voltage distribution systems that need a continuous power supply. They have been developed and meticulously tested for a long life. The changeover switch range comprises 25A, 40A and 63A in 2P and 4P versions.



Prevents Unauthorized Access

- **Provision for Padlock**
 - Can be used either in ON 1 or ON 2 position



- **True Position Indication**
 - Knob indicates actual position of the contacts inside

Range Highlights

- Conforms to IEC 60947-3 and IS/IEC 60947-3
- Available in 3 positions (I-O-II) with centre off position
- Utilization category AC-22A

Product Specifications

| ELECTRICAL | |
|-------------------------------------|----------------|
| Rated Operational Voltage | 240/415V |
| Rated Frequency | 50Hz/60Hz |
| Rated Insulation Voltage | 690V |
| Rated Impulse Withstand Voltage | 6kV |
| Rated Short-time Withstand Current | 20In for 1 sec |
| Rated Short-circuit Making Capacity | 1260A (Peak) |
| Electrical Life (Operating Cycles) | 10,000 |

| MECHANICAL | |
|------------------------------------|--------|
| Mechanical Life (Operating Cycles) | 10,000 |

| INSTALLATION | | | | | | | |
|-------------------------------|--|----------------------------|-------------|-------------------------------|----------------------------|-----------|-------------------------------|
| Mounting Position | Horizontal / Vertical / Flat | | | | | | |
| Terminal Capacity | <table style="border: none;"> <tr> <td style="border: none;">16 mm² (rigid)</td> <td rowspan="2" style="border: none;">} up to 40A</td> </tr> <tr> <td style="border: none;">10 mm² (flexible)</td> </tr> <tr> <td style="border: none;">25 mm² (rigid)</td> <td rowspan="2" style="border: none;">} for 63A</td> </tr> <tr> <td style="border: none;">16 mm² (flexible)</td> </tr> </table> | 16 mm ² (rigid) | } up to 40A | 10 mm ² (flexible) | 25 mm ² (rigid) | } for 63A | 16 mm ² (flexible) |
| 16 mm ² (rigid) | } up to 40A | | | | | | |
| 10 mm ² (flexible) | | | | | | | |
| 25 mm ² (rigid) | } for 63A | | | | | | |
| 16 mm ² (flexible) | | | | | | | |

| GENERAL | |
|-----------------------|----------------|
| Pollution Degree | 3 |
| Operating Temperature | -25°C to +60°C |
| Protection Degree | IP 20 |



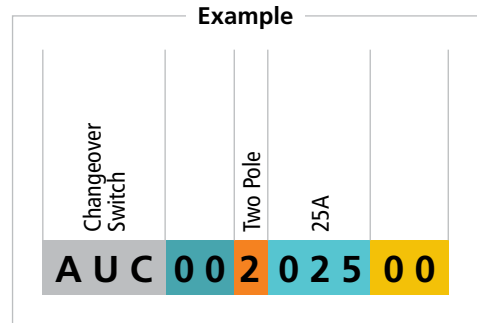

Decoding Product CAT Nos: AU-C

| | | | |
|----------------------------|-------------|------------|------------|
| Changeover Switches | AU C | | |
| Number of Poles | 2 | 4 | |
| | 2 Pole | 4 Pole | |
| Rating (A) | 025 | 040 | 063 |
| | 25A | 40A | 63A |
| | | | |



Product Range- AU-C

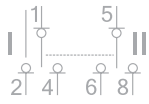

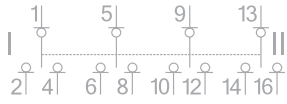
| Description | Rating | Modules | Cat. Nos. |
|---|--------|---------|--------------|
|  Double Pole  | 25A | 2 | AUC 00202500 |
| | 40A | 2 | AUC 00204000 |
| | 63A | 3 | AUC00206300 |
|  Four Pole  | 40A | 4 | AUC 00404000 |
| | 63A | 6 | AUC 00406300 |

Dimension Details – Changeover Switches

in mm

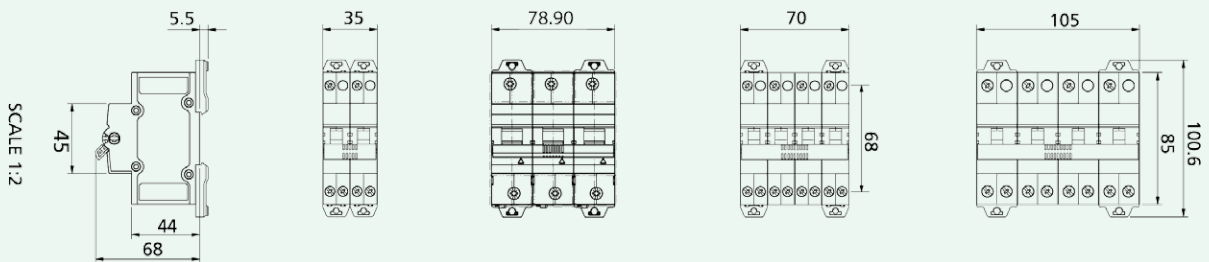

SIDE VIEW

2 POLE (25/40A)

2 POLE (63A)

4 POLE (40A)

4 POLE (63A)



Modular Contactors - The smart solution for remote switching

Modular contactors provide remote switching and automatic control of electric devices and equipment used in residential and commercial spaces.





Range Highlights

- Wide Range of Current Ratings:
 - 25A, 40A and 63A
- Conforms to:
 - IEC 61095, EN 61095
 - IEC 60497-4-1, EN 60497-4-1
 - IEC 60497-5-1
- Available in:
 - 1NO, 2NO, 3NO, 4NO and 2NO+2NC version
- Protection Degree IP 20

Product Specifications

| MAIN CIRCUIT | | CONTROL CIRCUIT | |
|---|--|----------------------|------------|
| Rated Operational Voltage | 230V/400V | Control Voltage (AC) | 12V-230V |
| Rated Insulation Voltage | 440V | Terminal Capacity | 2.5 sq.mm |
| Rated Impulse withstand Voltage | 4kV | Delay | 15-25 ms |
| Rated Frequency | 50Hz | Coil consumption | 12VA & 10W |
| Electrical Life for -AC-1/AC-7a (Operating Cycles) | 200000 (25A) 100000 (40A, 63A) | Frequency (AC) | 50/60 Hz |
| Terminal Capacity | 10 mm ² (rigid) } 25A 6 mm ² (flexible) } 25 mm ² (rigid) } 40A, 16 mm ² (flexible) } 63A | | |

Decoding Product CAT Nos.: AU-MC

| | | | | | | |
|---------------------------|-------------------|------------------|--------------------|------------------|----------------------|----------------------|
| Modular Contactors | AU MC | | | | | |
| NO+NC | 10 1NO | 20 2NO | 30 3NO | 40 4NO | 11 1NO+1NC | 22 2NO+2NC |
| Rating (A) | 025 25A | 40 40A | 63 63A | | | |
| No. of Modules | 01 One | 02 Two | 03 Three | | | |

Example

| | | | |
|----------------------|-----|-------|------------|
| Modular Contactor | 1NO | 25A | One Module |
| A U M C | 1 0 | 0 2 5 | 0 1 |

Product Range: AU-MC

| Description (AC-1) | Modules | Cat. Nos. |
|--|---------|----------------------------|
|  25A-1NO 25A-2NO | 1 | AUMC1002501 AUMC2002501 |



Product Range: AU-MC

| Description (AC-1) | Modules | Cat. Nos. |
|---|---------|-------------|
|  40A-2NO 40A-3NO 40A-4NO 63A-2NO+2NC 63A-3NO 63A-4NO | 3 | AUMC2004003 |
| | 3 | AUMC3004003 |
| | 3 | AUMC4004003 |
| | 3 | AUMC2206303 |
| | 3 | AUMC3006303 |
| | 3 | AUMC4006303 |
| | | |
| Auxiliary Contact, 2NO | 0.5 | AUMCAUX240 |

Dimension Details – Modular Contactors

in mm

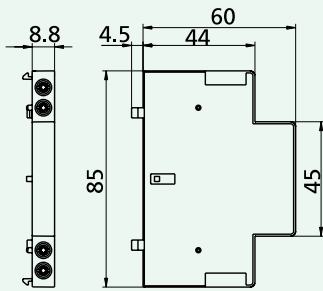

AUX CONTACT

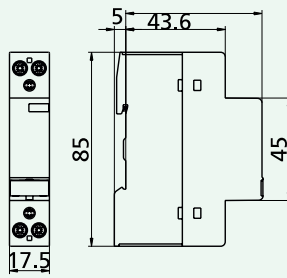

25A

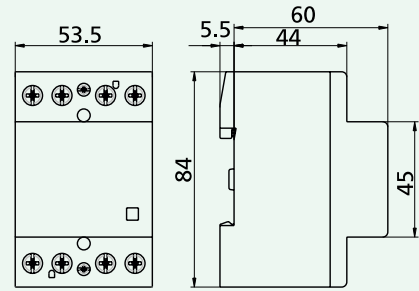

40A-63A



Time Switches - Ahead of their time

The AU Solutions range of Time Switches controls the ON and OFF operations of lighting and other loads. The range consists of Analog, Digital and Astro-time switches.



AU-TS Range of Time Switches



Reliability, simplicity and accuracy

Analog



- 1 Module (1 NO) and 3 Module (1 C/O)
- Power reserve of up to 150 hours
- Modular construction
- Inbuilt over-ride facility
- Minimum switching time: 30 min.

Digital



- Simple reset and manual override
- Keypad lock feature
- LED Indication for Relay Status
- 12/24-hour display format
- Weekend exclusion and weekly OFF programming
- 6-year battery reserve
- Minimum switching time: 1 min.
- 25 ON / OFF programmes

Astro



- Sunrise /sunset or twilight rise/set trigger modes
- Offset, OFF hours, weekly OFF feature
- 12/24-hour display format
- Easy manual override
- Ideal for outdoor and street lighting application
- Minimum switching time: 1 min.

Product Specifications

| | Electrical | | |
|---------------------------|----------------------------|----------------------------|-------|
| | Analog | Digital | Astro |
| Rated Operational Voltage | 230V AC/110V DC (1 Module) | 110-240V AC | |
| | 230V AC/130V DC (3 Module) | - | - |
| Power Consumption | 1 VA | 6 VA | |
| Resistive Load | 16A/250V AC | 16A (For NO) & 5A (For NC) | |
| Inductive Load | 4A/250V AC | 6A/250V AC | |
| Incandescent Lamp load | 1000W (1 Module) | 1000W | |
| | 1350W (3 Module) | - | - |
| Switching Time | 30 min. | 1 min. | |
| LED indication | - | Red LED for relays status | |

| | MECHANICAL | | |
|--------|------------------|---------|-------|
| | Analog | Digital | Astro |
| Output | 1 NO (1 Module) | 1 C/O | |
| | 1 C/O (3 Module) | - | |



GENERAL

| | Analog | Digital | Astro |
|------------------------|-----------------------|---|---------------|
| Accuracy | ±1.5 sec/day at +20°C | ±2 sec per day over the operating temp. range | |
| Operating Temperature | -20°C to +55°C | -10°C to +55°C | |
| Supply Failure Reserve | 150 Hrs. rechargeable | 6 years | |
| Manual Override | Yes | | |
| Modes | ON, OFF*, AUTO | ON, OFF, Auto On, Auto Off, Auto | ON, OFF, AUTO |
| Protection Degree | IP 20 | | |

* For 3 Module variant

Decoding Product Cat Nos.: AU-TS

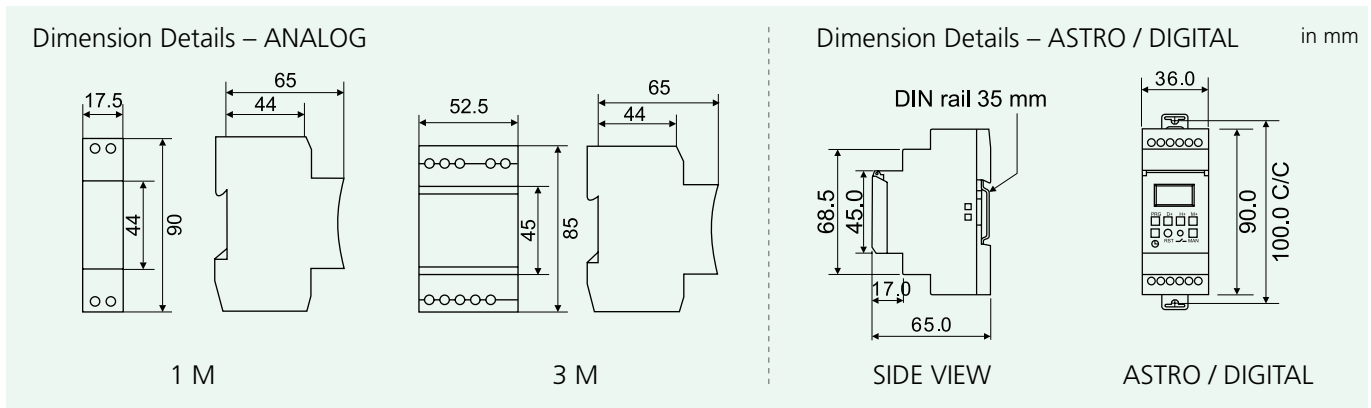
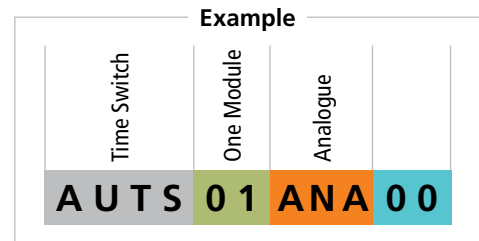
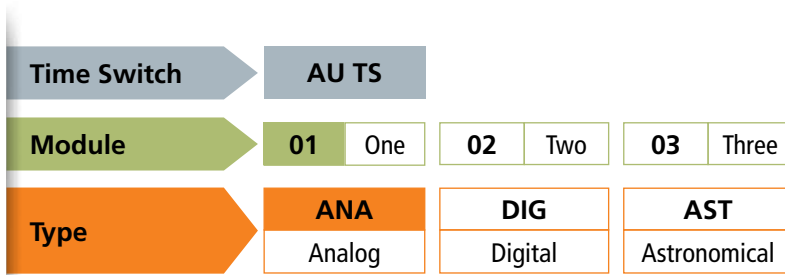

Product Range: AU-TS

| Description | Modules | Cat. Nos. |
|---------------------|---------|-------------|
| Analog time switch | 1 | AUTS01ANA00 |
| Analog time switch | 3 | AUTS03ANA00 |
| Digital time switch | 2 | AUTS02DIG00 |
| Astro time switch | 2 | AUTS02AST00 |



Controlling Devices - ACCL

Automatic Changeover with Current Limiter

A perfect solution for efficient distribution of generator power in high-rise apartments, townships, and commercial buildings. ACCL consists of three separate pair of terminals – two for connecting single phase supplies (main and back-up) and one for connecting single phase load. The ACCL will switch the load to back-up/generator supply when main/default supply goes off. On resumption of default supply, ACCL will automatically switch from back-up to default supply.





Intelligent and Reliable

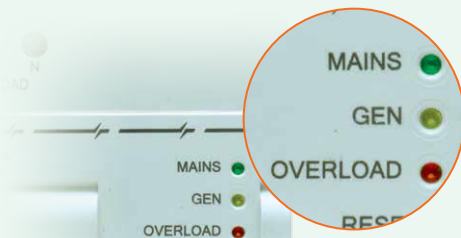

LED indication
Different LED colors for clear differentiation between Mains ON , Genset ON and Genset Overload



Reset Button
To Restore the supply to load, after non essential loads are switched off

Range Highlights

- Conforms to IEC 60947-6, IEC 60947-3
- Wide Range of Current Ratings
 - (Generator side) – 1.5A to 30A
 - (Electricity Boards side)- 30A
- No. of Poles 1P+N
- Protection Degree - IP20
- Reliable microcontroller based design for sensing & control
- Lower power consumption
- RoHS compliant

Product Specifications

| ELECTRICAL | |
|------------------------------------|---|
| Rated Operational Voltage | 230V |
| Rated Insulation Voltage | 500V |
| Rated Impulse Voltage | 2.5kV |
| Rated Frequency | 50Hz |
| Electrical Life (Operating Cycles) | 6000 |
| Utilization Category | AC 31B (IEC 60947-6) / AC 21A (IEC 60947-3) |
| Conditional short circuit current | 3kA |
| Dielectric strength | 2kV |

| MECHANICAL | |
|-------------------------------|--|
| Changeover time (Mains to DG) | ~ 11 sec. |
| INSTALLATION | |
| Terminal Capacity | 6 mm ² (flexible) 10 mm ² (rigid) |
| GENERAL | |
| Operating Temperature | -5°C to 50°C |

Decoding Product CAT Nos.: AU-CL

| | | | | | | | | |
|---------------|--------------|------|-----|-----|-----|-----|-----|-----|
| ACCL | AU CL | | | | | | | |
| Phase | 01 | | | | | | | |
| | Single Phase | | | | | | | |
| EB Rating (A) | 030 | | | | | | | |
| | 30A | | | | | | | |
| DG Rating (A) | 1E5 | 2E5 | 003 | 004 | 005 | 006 | 008 | 010 |
| | 1.5A | 2.5A | 3A | 4A | 5A | 6A | 8A | 10A |

Example

| | | | |
|----------------|--------------|----------------|----------------|
| ACCL | Single Phase | EB Rating- 30A | DG Rating 1.5A |
| A U C L | 0 1 | 0 3 0 | 1 E 5 |



Product Range: AU-CL

| Description | Single Phase ACCL | Modules | Cat. Nos. |
|---|-------------------|---------|---------------|
|  | 30A/1.5A | 4 | AUCL010301E5 |
| | 30A/2.5A | 4 | AUCL010302E5 |
| | 30A/3A | 4 | AUCL01030003 |
| | 30A/4A | 4 | AUCL01030004 |
| | 30A/5A | 4 | AUCL01030005 |
| | 30A/6A | 4 | AUCL01030006 |
| | 30A/8A | 4 | AUCL01030008 |
| | 30A/10A | 4 | AUCL01030010 |
| | 30A/12A | 4 | AUCL01030012 |
| | 30A/15A | 4 | AUCL01030015 |
| | 30A/20A | 4 | AUCL01030020 |
| | 30A/30A | 4 | AUCL01030030* |

* Non-current limiting variant

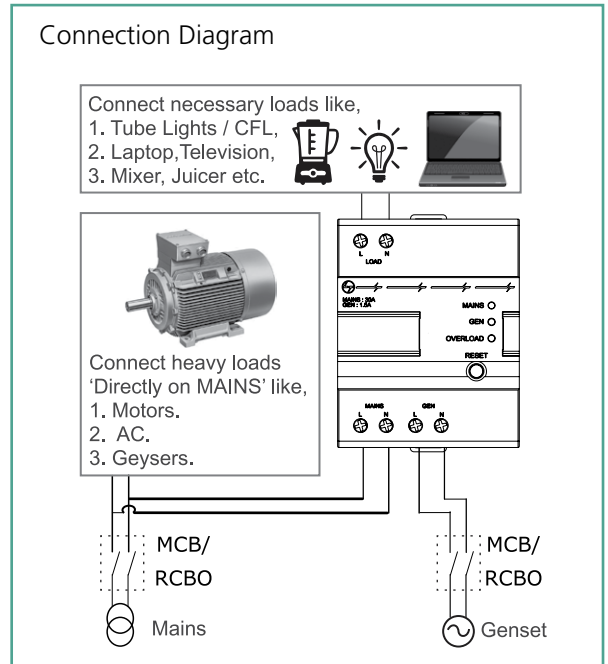
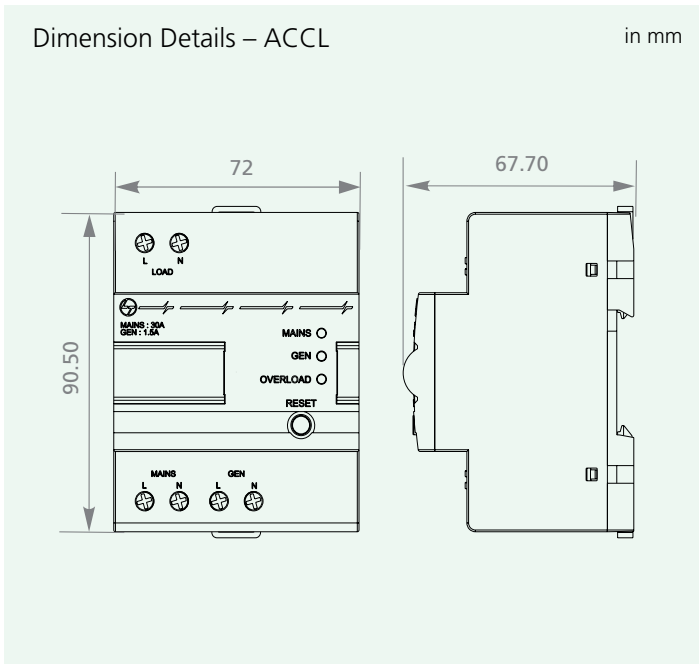

Recommended Backup MCB Ratings:

| ACCL Ratings | | MCB Ratings | | ACCL Cat. Nos. |
|--------------|--------|---------------|----------------|----------------|
| Mains | Genset | On Mains Side | On Genset Side | |
| 30 A | 1.5 A | 32 A | 2 A | AUCL010301E5 |
| | 2.5 A | | 3 A | AUCL010302E5 |
| | 3 A | | 3 A | AUCL01030003 |
| | 4 A | | 4 A | AUCL01030004 |
| | 5 A | | 5 A | AUCL01030005 |
| | 6 A | | 6 A | AUCL01030006 |
| | 8 A | | 10 A | AUCL01030008 |
| | 10 A | | 10 A | AUCL01030010 |
| | 12 A | | 16 A | AUCL01030012 |
| | 15 A | | 16 A | AUCL01030015 |
| | 20 A | | 20 A | AUCL01030020 |
| | 30 A | | 32 A | AUCL01030030 |

Timing Diagram:

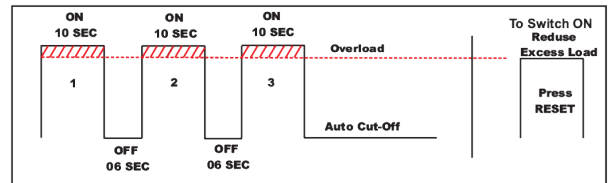



AU-COM - For Smart Systems

The AU Solutions range of final distribution products can be made communication-capable with AU-COM. The ease of use of the AU-COM user interface makes it a true, real-world solution.





Simplicity in communication

AU-COM addresses the remote monitoring and controlling requirement of the building and industrial segments. The communication solution consists of AU-COM & AU-CON (an optional Converter Module).

Range Highlights

- Can be deployed for AU range of MCBs, RCCBs, RCBOs and energy meters
- Capable of local and remote status monitoring of final distribution products- ON, OFF and TRIP
- With AU-COM and modular contactors AU-MC, remote controlling of the load can be achieved
- The convertor module converts RS 485 data signals from AU-COM into SCADA-compatible ethernet signals
- For remote monitoring and metering of energy, single-phase and three-phase energy meters with RS 485 converters or Wi-Fi modules can be used

Communication Solution

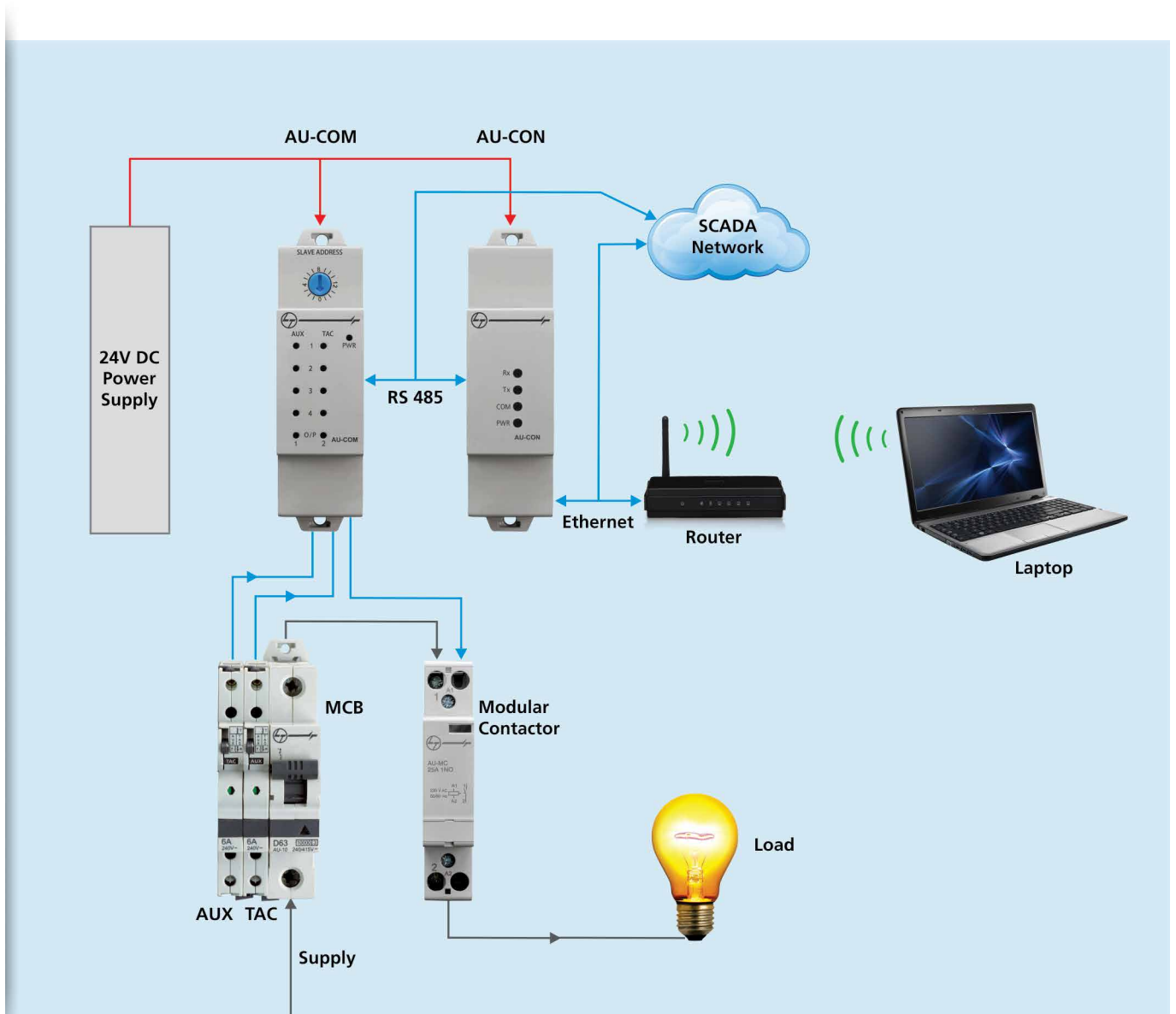



- In absence of control circuits, one can connect a maximum of 4 Auxiliary Contacts (AU-AUX) and 4 Trip Alarm Contacts (AU-TAC) with AU-COM
- With 2 control circuits in place, a maximum of 2 Auxiliary Contacts and 2 Trip Alarm Contacts can be deployed for status monitoring
- In all, 15 AU-COM modules can be connected in the system.

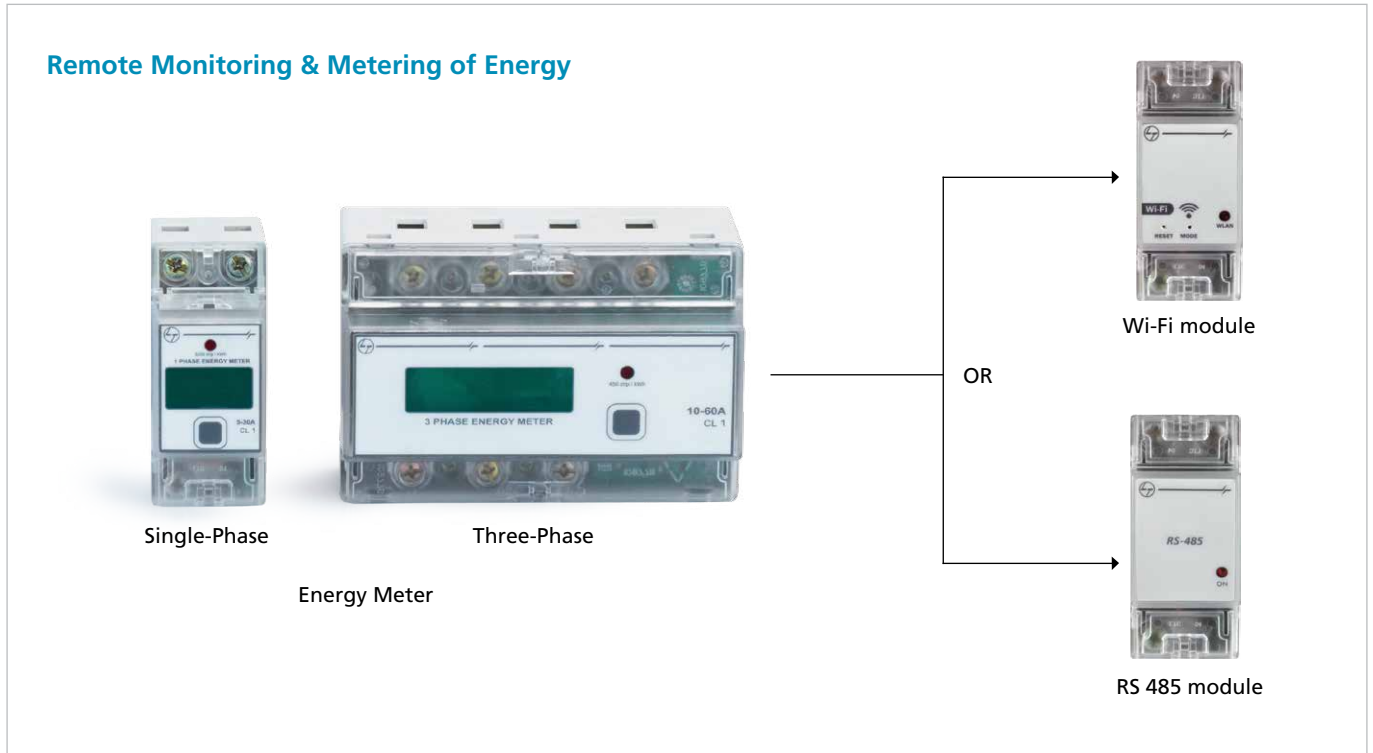

Product Specifications

| Wi-Fi module | |
|------------------------------|-------------------------------|
| Voltage rating | 240 V (-30% to +20% AC) |
| Operating temperature | -10°C to 55°C |
| Power consumption | < 1W, 1VA in voltage circuits |
| Dimensions (H x W x D in mm) | 83mm x 36mm x 66.5mm |
| Weight | 115 g |

For Single and three phase energy meter

| RS 485 module | |
|------------------------------|-------------------------------|
| Protocol | RS 485 RTU |
| Baud rate | 1200, 2400, 4800, 9600, 19200 |
| Parity | None, Odd, Even |
| Voltage rating | 240 V (-30% to +20% AC) |
| Operating temperature | 20°C to 70°C |
| Dimensions (H x W x D in mm) | 83mm x 36mm x 66.5mm |
| Weight | 115 g |

For Single and three phase energy meter



AU-COM & AU-CON

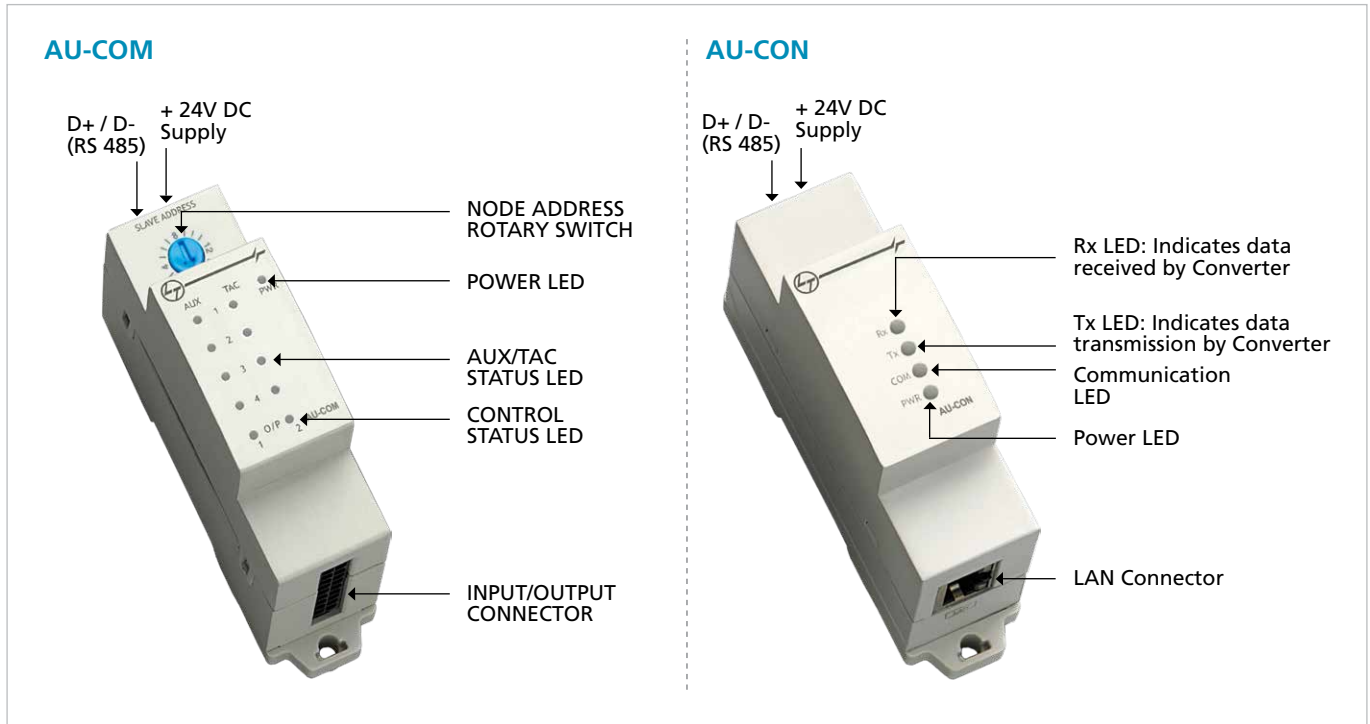

Product Specifications

| AU-COM | |
|------------------------------|--|
| Conforms to | IEC 61131-2 |
| Connection with HMI | Modbus-RTU (RTU Via TCP) |
| Breaker interface | 4 Aux & 4 TAC |
| Output Control | 2 Potential-free contacts for operation using relay (240VAC, 8A) |
| Power Supply | 24V DC |
| Mounting | DIN Rail mountable |
| Dimensions (H x W x D in mm) | 85mm x 26.3mm x 60mm |

| AU-CON | |
|------------------------------|--|
| Baud rate supported | 1200, 2400, 4800, 9600, 19200, 8400, 57600, 115200 |
| Ethernet | 10/100Mbps |
| Power consumption | 50mA at 24V DC, 2Watt max. |
| Dimensions (H x W x D in mm) | 85mm x 26.3mm x 60mm |

| Modbus | |
|---------------|---|
| Node address | 1-15 (using hexadecimal rotary switch)* |
| Baud rate | 9600 |
| Parity | None |
| Stop Bit | One |

Ordering information

| Description | Module | CAT Nos. |
|---|--------|-------------|
| AU-COM communication module | 1.5 | AUCOM0402 |
| AU-CON convertor module | 1.5 | AUCON0403 |
| RS-485 module for single and three-phase energy meter | 2 | W1DLD0000RS |
| Wi-Fi module for single and three-phase energy meter | 2 | W1DLD0000WF |

*Node Address '0' corresponds to default address of 1



Technical References

1. Understanding Final Distribution Level

Electricity is generated far from residential areas and complexes or load centers. It is transmitted from the points of generation to different load centers. The conventional methods for generation of electricity are hydro, thermal and nuclear.

Electric energy, obtained in the electric generation process, must be transmitted to the end-user by conductors of electricity without large resistive power losses in the distribution process. A key part in this process is the usage of transformers for increasing the voltage to hundreds of thousands of volts to minimize heating losses in the transmission lines.

The three high-voltage conductors on any utility pole indicate that the power distribution is on 'three-phase', with each conductor 120 degrees away from each other. At the load end of the circuit, the return paths of the three phase circuits can be coupled together at the neutral point.

In the case of end-users like street lights or residential consumers, only a single phase supply is needed. When distributing three-phase electric power, a fourth or neutral cable is run in distribution to provide a single phase circuit to each house. Different houses in the street are placed on different phases of the supply so that the load is balanced, or spread evenly, across three phases. Thus, the supply cable to each house would consist of a live and neutral conductor with possibly an earthed armoured sheath.

Major classes of loads generally used at the Final Distribution level are:

- Single-phase AC motors
- Incandescent Lamps
- Fluorescent Lamps
- Computer/UPS
- Other Electronic Loads

2. Types of Faults

There are various faults associated with distribution of electricity:

- a. Overcurrent fault
- b. Electric shock / leakage
- c. Undervoltage
- d. Overvoltage
- e. Surges

a. Overcurrent fault

In electricity supply, overcurrent or excess current is a situation in which an electric current larger than that intended passes through a conductor, leading to excessive generation of heat and the risk of fire or damage to equipment. Possible causes for overcurrent include short circuits, excessive load, and incorrect design. Fuses, circuit breakers, temperature sensors and current limiters are the commonly used protection mechanisms to control

the risks of overcurrent.

b. Electric Shock / Leakage

An electrical shock occurs when any part of a human body comes in contact with a source of electric current and it provides an unintended path and 'completes the circuit' between the electric source and ground. This electrical shock can simply cause a minor jolt, but it can also be fatal. A possible cause of an electric shock can be a puncture in the wire insulation.

c. Undervoltage

Undervoltage is defined as a condition where the applied voltage drops to 90% of the rated voltage, or less. Low-voltage conditions occur when a facility asks for more power than the line can deliver. In this situation, voltage drops somewhere between full power and a blackout. Common effects of such occurrences are noticeable, such as significant dimming of regular incandescent lights. The point to be noted here is it is not always an issue of the electric utility not having adequate capacity; transformers can act like a choke, restricting how much total power gets through to the system. Motors typically will end up drawing higher current in case of undervoltage situations, causing over-heating leading to subsequent destructions.

d. Overvoltage

Electronic and electrical devices are designed to operate at a certain maximum supply voltage, and considerable damage can be caused by a voltage that is higher than what the devices are rated for.

For example, an electric load (light bulb), at the given rated voltage, will carry current just large enough for the wire to get very hot but not hot enough for it to melt. The amount of current in a circuit depends on the voltage supplied. If the voltage is too high, then the wire may melt and the light bulb would have 'burned out'. Similarly, other electrical devices may stop working, or may even burst into flames if an overvoltage is delivered to the circuit.

e. Surges

Surges or transients are brief overvoltage spikes or disturbances on a power waveform that can damage, degrade, or destroy electronic equipment within any home, commercial building, industrial, or manufacturing facility. Transients can reach amplitudes of tens of thousands of volts. Surges are generally measured in microseconds.

Every piece of electrical equipment is designed to operate at a specified nominal voltage such as 120 V, 240 V, 480 V, and so on. Most of the equipment are designed to handle minor variations in their standard nominal operating voltage. However, surges can be very damaging to nearly all equipment.



3. Protection Devices

MCBs (Miniature Circuit Breakers)

Miniature Circuit Breakers are electromechanical devices that protect an electrical circuit from overcurrent. The overcurrent, in an electrical circuit, may result from short circuit, overload or faulty circuit design.

An MCB comes into operation in two main circumstances: First, due to the thermal effect of overcurrent (overload) and second, due to electromagnetic effect of overcurrent (short circuit). The thermal tripping of an MCB is achieved with a bimetallic strip. Whenever continuous overcurrent flows through MCB, the bimetallic strip is heated and deflects. This deflection of bimetallic strip releases mechanical latch. As this mechanical latch is attached with operating mechanism, it causes the MCB contacts to open. But during short-circuit, the sudden rise in electric current causes electromechanical displacement of plunger associated with tripping coil or solenoid of MCB. This plunger strikes the trip lever, causing immediate release of the latch mechanism, consequently opening the circuit breaker contacts.

In simple terms, an MCB is a switch that automatically turns off when the current flowing through it passes the maximum

allowable limit. It is a better alternative to a fuse, since it does not require replacement once an overload is detected. Unlike a fuse, an MCB can be easily reset, and thus offers improved operational safety and greater convenience without incurring high operating cost.

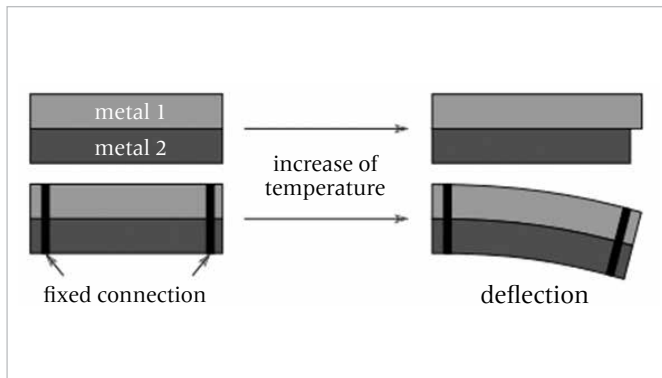
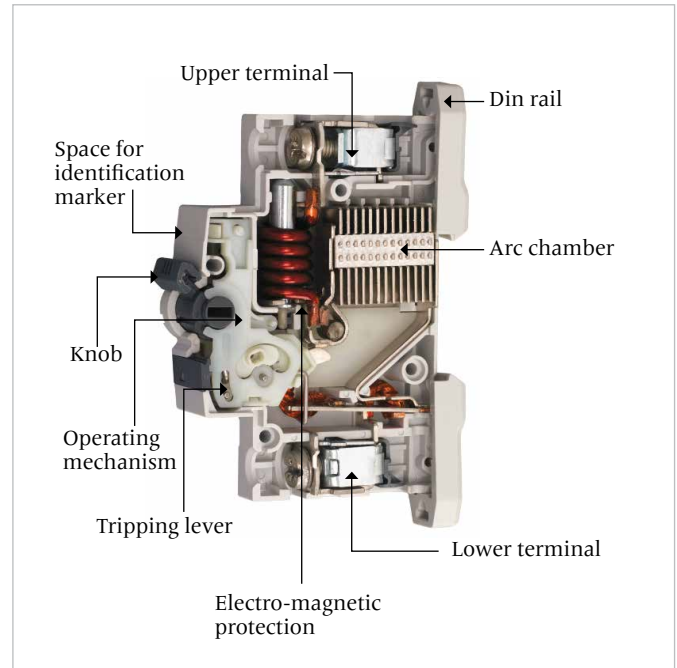

Bimetallic strip

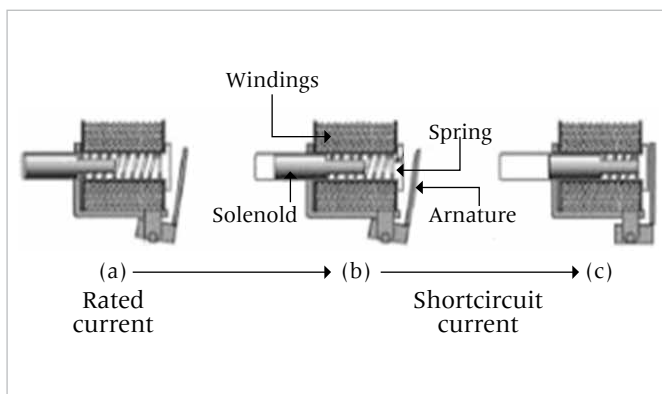

Solenoid

RCDs (Residual Current Devices)

It is a generic term which encompasses various forms of RCCBs and RCBOs. An RCD protects by constantly monitoring the current flowing in the live and neutral wires supplying to a circuit or an individual piece of equipment. Under normal circumstances, the current flowing in the two wires is equal. When an earth leakage occurs due to a fault in the circuit or an accident with the equipment, an imbalance occurs and this is detected by the RCD which automatically cuts off the power before any injury or damage takes place.

RCCB (Residual Current Circuit Breaker)

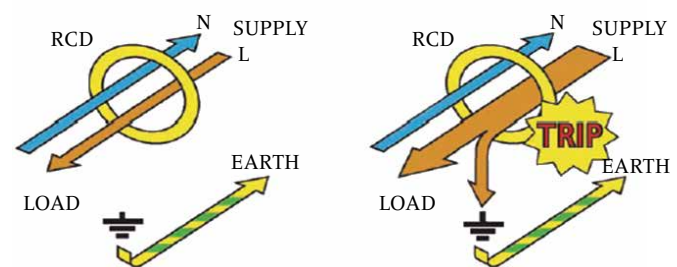

RCCBs are designed to give protection against earth leakages. These are not intended to provide protection against overload or short-circuit conditions.



RCBOs (Residual Current Circuit Breaker with Overcurrent Protection)

An RCBO is a mechanical switching device designed to make, carry and break currents under normal service conditions and cause the opening of the contacts when the residual current attains a given value under specified conditions. In addition, it is designed to give protection against overloads and short-circuits. It is a combination of RCCB and MCB which provides 3-in-1 protection against earth leakages and over-currents due to short circuit and over-loading.

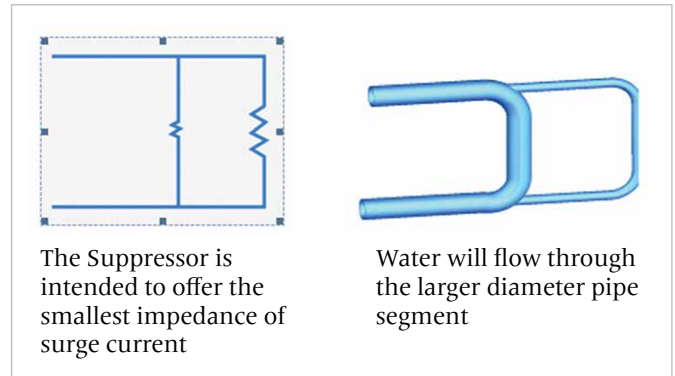

SPDs (Surge Protection Devices)

SPDs are devices that shield electromechanical / electrical / electronic circuits or equipment from a sudden and destructive increase (surge) in the line voltage caused usually by direct lightning strikes, indirect lightning strikes, or due to faults of in-house operational devices. It does this by momentarily 'switching' from an open-circuit / high-resistance mode into a low-impedance mode sensing the overvoltage. This low impedance mode diverts the surge current through it and in doing so, limits the overvoltage to a safe level. When the surge event is over, the protector returns to its open circuit mode.

Surge Protection Device Analogy with Water flow

Surge protection method can be best understood by water flow analogy. To control the flow of water, it needs to be stopped/regulated at different locations so that only the required volume of water flows to the receiving end and is productively utilized, Similarly, to control the electrical surges in the system in permissible limit, the excess current which is generated due to a surge needs to be removed from the system. This is achieved by a Surge Protection Device (SPD).

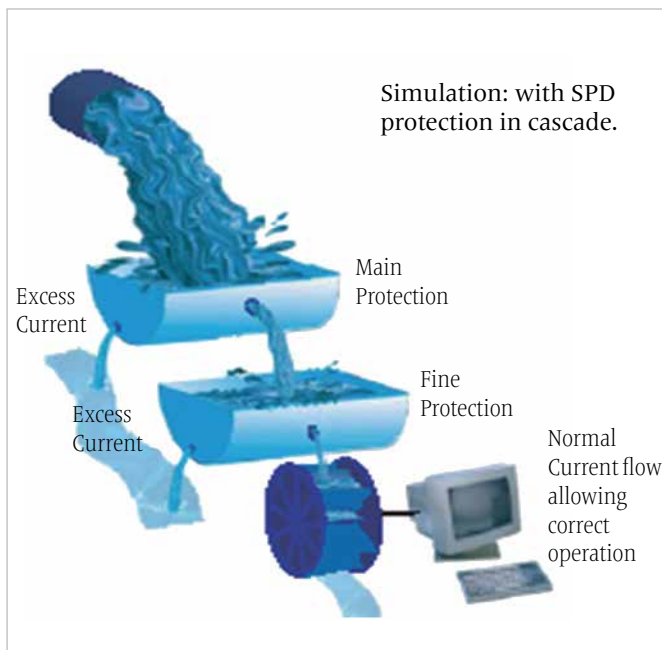

- **Nominal/Operating Voltage (Un):** The nominal voltage stated for a SPD corresponds to the system voltage of the typical SPD installation site, e.g., 230/400 V AC.
- **Maximum continuous voltage (Uc):** Maximum r.m.s. voltage that can be applied continuously to the terminals of the SPD.
- **Temporary overvoltage (UT):** TOV is the maximum r.m.s. voltage that the SPD can withstand for 5 seconds, without failure.
- **Voltage protection level (Up):** Maximum voltage that can occur on the connection terminal blocks of the SPD. In the event of a surge voltage or surge current within the performance parameters of the SPD, the voltage is safely limited to a maximum of this value at the protected connections of the SPD.
- **Nominal Discharge Current (In):** The nominal discharge current (In) is the level of impulse current a surge protector can withstand repeatedly (15 surges) without destruction
- **Impulse current (Iimp):** Maximum impulse 10/350 μs current a surge protector can withstand without destruction. The pulse shape (10/350 μs) of a surge current is used for simulating the current flow of direct lightning strikes.
- **Maximum discharge current (Imax):** Maximum impulse 8/20 μs current a surge protector can withstand without destruction. The pulse shape (8/20 μs) of a surge current is characteristic of the effects of an indirect lightning strike or switching operation.



4. Selection Of MCBs

An MCB is an automatically-operated electrical switching device, designed to protect an electrical circuit from damage due to overcurrents. Its basic function is to detect a fault condition, interrupt continuity and to immediately discontinue flow of current. Unlike a fuse, which operates once and then has to be replaced, a circuit breaker can be reset (manually) to resume normal operation.

Over-currents are chiefly due to two reasons:

a. Short-circuit

b. Overload

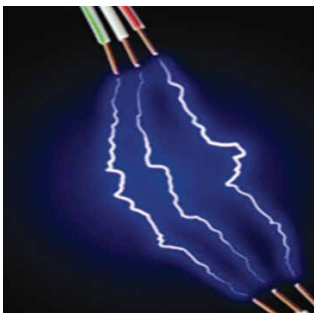

The inverse time delay characteristics as per MCBs, complying with IEC 60898, must operate within the limits specified below:

I_n = rated current

a. Overload (Thermal characteristics)

| Fault Current | Trip Time |
|---------------|---------------------|
| 1.13 I_n | Greater than 1 hour |
| 1.45 I_n | Less than 1 hour |
| 2.55 I_n | 1 to 120 seconds |

b. Short-circuit (Magnetic characteristics)

| Curve Type | Breaker Trip limits |
|------------|----------------------|
| Type B | 3 to 5 times I_n |
| Type C | 5 to 10 times I_n |
| Type D | 10 to 20 times I_n |

Selection of an MCB depends mainly on the following three parameters:

- i. Current Rating of the MCB
- ii. Characteristic Curve as per the application
- iii. Short-circuit breaking capacity in line with fault level

i. Selecting current rating of an MCB

In order to achieve perfect overload protection, the rated current (I_n) of an MCB should not be less than the design current or rated current (I_c) of the circuit and that (I_n) should not exceed the current carrying capacity of the conductor or wire (I_w).

$$I_c < I_n < I_w$$

As per the thermal characteristics table the (I_w) should be a minimum of 1.45 times (I_n).

For Example:- For a load of 1200 W, 240V supply, the load current is 5 A

$$P = V I \text{ (resistive load)}$$

Where P = power in Watt, V = Voltage in Volts and I = Current in Ampere

Hence, the rating of an MCB to be selected should be equal to or greater than 5 A and the nearest MCB rating available is 6A.

And the minimum trip current for the MCB is $6A \times 1.45 = 8.7 A$

Accordingly, the wire size should be selected with a current carrying capacity of more than 8.7 A

So, the nearest wire size available with current carrying capacity of more than 8.7 A is 11 A (i.e 1 sq mm) - as per IS:3961)

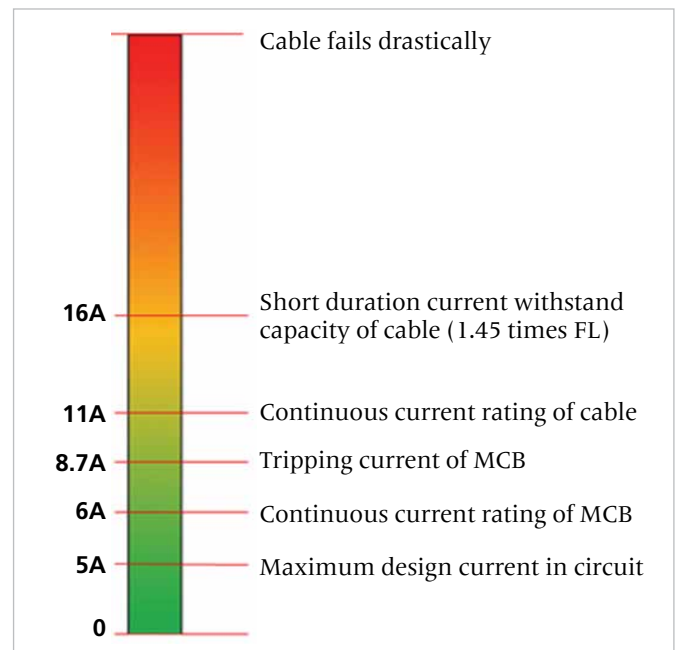



ii. Selecting Characteristic curve of an MCB

| Type | Setting | Application |
|------|----------|---|
| B | 3-5 In | Generators-sensitive loads very long circuit runs Examples : Incandescent lights, heater, geyser |
| C | 5-10 In | General, light and power Example : Fluorescent lights, small motors, fans, refrigerators, window/split ACs |
| D | 10-20 In | Transformers sodium lighting highly inductive loads Examples : Water lifting pumps, UPS |

Typical Characteristic Curves of an MCB are as shown below:

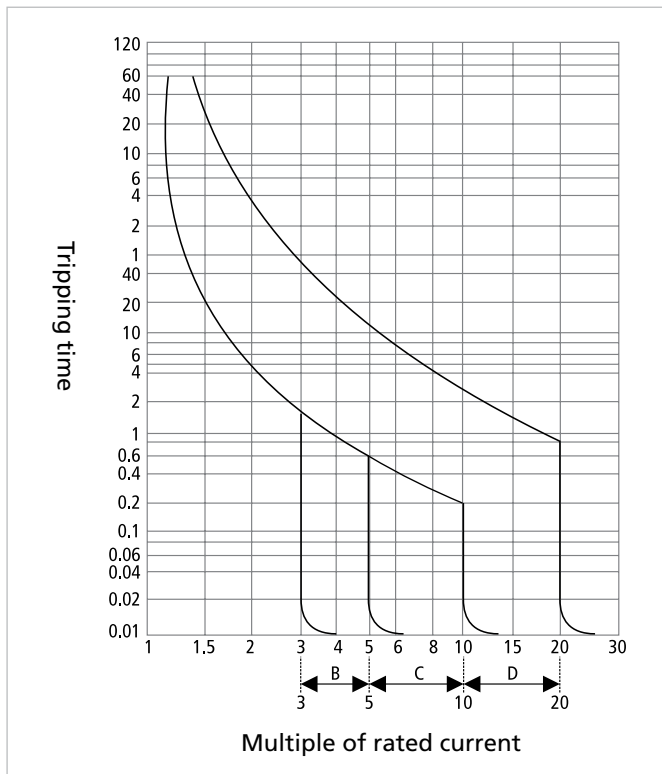

General B, C and D curve Characteristics

MCBs are typically offered in B, C and D characteristics. For an application involving purely resistive loads such as incandescent lights and heaters, MCBs with characteristic B are used. If the load is split ACs or refrigerators, B-curve MCBs might offer nuisance tripping due to high level of initial currents. In such conditions, one needs to choose C-curve MCBs. Further, there can be applications such as UPS where even C-curve MCBs might offer nuisance tripping due to very high level of inrush currents. In such scenarios, D-curve MCBs are best suited. Therefore, it is advisable to select appropriate MCBs as per the requirements of the specific application.

iii. Selecting short circuit breaking capacity of an MCB

The third selection parameter is the short circuit breaking capacity, which is required to protect against heavy current, which maybe

in thousands of amps is caused by a short-circuit. The ability of an MCB to protect from this fault is defined by its short-circuit rating.

The fault level depends primarily on:

- 1. Transformer rating:** Fault level is directly proportional to the transformer rating.
- 2. Fault impedance:** If the distance of fault from the source (transformer in this case) is less, the fault impedance is less and thus the fault level is high and vice versa.

5. Selection of RCDs

RCD is a general term for Residual Current Devices.

RCCB: Residual Current Circuit Breaker

RCBO: Residual Current Circuit Breaker with Over current Protection

Selection between RCCB and RCBO

Depending upon the requirement of overcurrent protection, one can choose between the RCCB and RCBO. If only residual current protection is required, then an RCCB should be considered.

How to select an RCCB/RCBO?

Selection of RCCB/RCBO is dependent on the following parameters:

- Types of RCD
- Rated residual tripping current
- Operating time

Selecting Type of RCD

i. Types of RCD

RCDs are classified into the categories listed below in accordance with their ability to ensure protection against various types of residual currents:

| Type | Description | Application |
|-------|---|---|
| AC | For - pure AC current | Electrical devices (non-electronics) |
| A | For - pure AC current - pulsating DC | Electrical devices (electronics and non-electronics) |
| B & F | For - pure AC current - pulsating DC - smooth DC | Electrical drives Frequency inverters Computed tomography |
| Adi | For - pure AC current - pulsating DC - harmonics and transients | IT parks Data centers |

ii. Rated residual tripping current

RCDs can be provided with varieties of rated residual operating current. Its range could vary from 10mA to 500mA.



30mA is the maximum value permissible for personal shock protection and 300mA is the maximum value permissible for fire protection. Non-standard values may be used, but the shock and fire limits must not be exceeded.

RCDs can be used where it is necessary to protect a circuit or an installation against dangerous residual currents. The three main areas for such protection are as follows:

- a. Protection against fire.
- b. Fault protection (protection against indirect contact)
- c. Basic protection (protection against direct contact)

| Sensitivity | Typical Applications |
|-------------|--|
| 10mA | Human protection-wet areas, swimming pools, jacuzzis |
| 30mA | Human protection-kitchens, bathrooms, laboratories, schools & workshops |
| 100mA | Installations where there is inherent seepage / with limited personal protection |
| 300mA | Cable / fire protection |
| 500mA | Special purpose machines |

iii. Operating time

RCDs fall into two categories in terms of the time taken to respond to and clear residual currents, as follows:

a. General Type: These RCDs have no specified minimum response time but have specified maximum response time

$I_{\Delta N} : T < 300\text{ms}$
 $5 I_{\Delta N} : T < 40\text{ms}$

b. S Type: These RCDs, commonly known as delayed types, have specified minimum and maximum response time, as follows:

$I_{\Delta N} : 130 - 500\text{ms}$
 $5 I_{\Delta N} : 50 - 150\text{ms}$

Delayed response (S Type) RCDs are commonly fitted upstream of general type RCDs, but general type RCDs should never be fitted upstream of delayed types.

The term 'upstream' refers to proximity to the origin of the installation and 'downstream' refers to proximity to the load.

6. Selection of SPDs

Selection of SPD depends on following parameters:

- i. Type of equipment to be protected
- ii. According to different types of standards

i. Type of equipment to be protected

All the electrical and electronic devices have some impulse voltage withstand capacity. So, it is required to keep impulse voltage within this limit. These high voltages are generated because of lightning surges of voltage transients. Typical impulse withstands capacity for various equipment is as below:

| Category | I | II | III | IV |
|--------------------------------|--------------------|---|---|----------------|
| impulse voltage withstand (kV) | 1.5 | 2.5 | 4 | 8 |
| Type of equipment | Electronic devices | Electrical appliances (refrigerators, oven, etc.) | Distribution and final circuits (motors, sockets, etc.) | Incomer, meter |

ii. According to different types of standards

As per international standards, SPDs are classified as lightning current arresters (Class I), surge protection devices (Class II) or device protection (Class III). Each class is defined by performance testing methods for surge current handling capability.

Type 1 / Class I SPDs (lightning arresters) are mainly installed in the electrical entry panel or the Main Distribution Panel. This is the first stage protection in the electrical network, and the surge arrester is designed to divert lightning energy caused by an overvoltage comparable to that of a direct lightning strike to the power lines or equipment. These protectors must be designed to survive the 10/350 μs waveform. In addition, Class I lightning arresters are tested with 8/20 μs current impulses for nominal discharge current ratings. These SPDs are called Type 1+2 SPDs.

It must be understood that Class I SPDs are only for insulation breakdown protection; e.g. protecting the wires, insulation/dielectrics, and other components of the electrical distribution system. These SPDs are not intended to prevent damage to electronics and sensitive equipment. Most SPD manufacturers use discharge gap technology to meet the challenging test requirements of surviving multiple 10/350 μs wave shape hits without damage or degradation. The discharge gap handles high surge currents of 100kA and does not suffer from leakage current when not conducting. Typically, Type 1 SPDs provide impulse withstand voltage level of 1.5 - 2 kV.

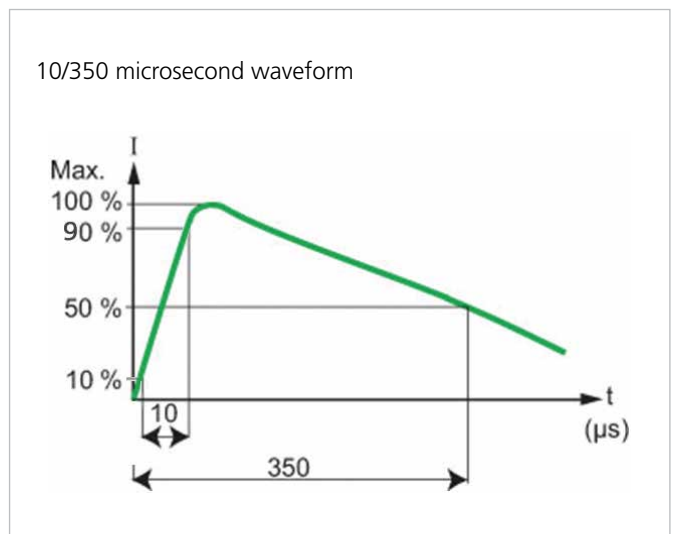

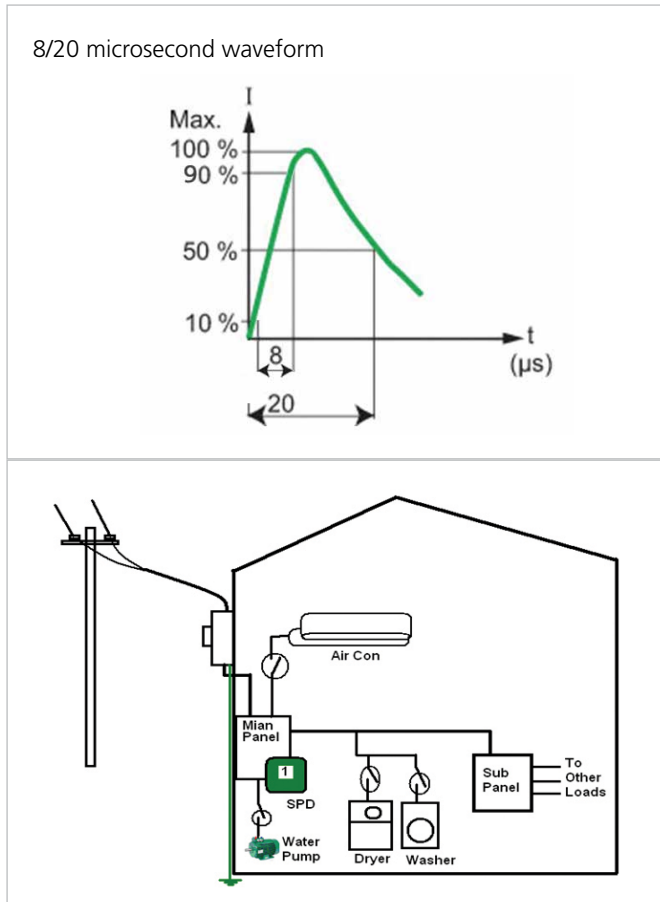

Type 2 / Class II SPDs are mainly installed in secondary distribution panels as the second stage of protection. The Class II SPD along with the first stage Class I arrester provides a better level of protection to equipment. These SPDs offer a lower surge capacity and provide a lower clamp level than the primary suppressor. These SPDs also suppress any surge currents generated by induced lightning currents / partial lightning and operational switching action in the electrical network. These SPDs are tested with 8/20µs surge currents, and typically offer a voltage protection level of around 1.5-1.2 kV. It is important to note that this voltage level can still potentially allow damage to sensitive equipment.

Type 3 / Class III SPDs must be installed as a supplement to Type 2 SPDs and can be located in the immediate vicinity of sensitive loads. Critical applications with sensitive equipment include medical imaging, cloud servers, and video surveillance. The function of a Class 3 device is protection of sensitive electronic equipment and thus the voltage protection level should be < 600 V. These devices are tested similar to the Class II SPDs (1.2/50 µs and 8/20 µs waveforms) but have lower discharge current capability. Many times, Type 2 products are declared as Type 3 and, it is, therefore, important to check that these SPDs offer voltage levels of ≤ 600 V.

| Coordination Stage | Stage 1 | Stage 2 | Stage 3 |
|--------------------|--------------------------|-------------------------|--------------------------|
| Surge Threat | Lightning | Lightning & Inductive | Inductive |
| IEC 61643-1 | Class I test (10/350 µs) | Class II test (8/20 µs) | Class III test (8/20 µs) |
| EN/IEC 61643-11 | Type 1 : (10/350 µs) | Type 2 : (8/20 µs) | Type 3 : (8/20 µs) |
| IEC Test Waveform | 10/350 µs | 8/20 µs | 1.2/50 µs + 8/20 µs |
| IEEE C62.41 | Location C (10/350 µs) | Location B (8/20 µs) | Location A (8/20 µs) |
| UL 1449 | Type 1 (10/350 µs) | Type 2 (8/20 µs) | Type 3 (8/20 µs) |
| IEEE Test Waveform | 10/350 µs | 8/20 µs | 1.2/50 µs + 8/20 µs |

7. General Terminologies (Reference IEC 60947-1)

a. Degree of Pollution

Pollution degree of environmental conditions is a classification based on the amount of conductive dust, ionized gas or salt and on the relative humidity and its frequency of occurrence resulting in condensation of moisture leading to reduction of dielectric strength. In short, 'Pollution Degree' refers to the environmental conditions for which the equipment is intended.

As per IEC, the four degrees of pollution are defined as follows:

Pollution Degree 1:

No pollution or only dry, non-conductive pollution occurs.

Pollution Degree 2:

Normally, only non-conductive pollution occurs. Occasionally, however, temporary conductivity caused by condensation may be expected.

Pollution Degree 3:

Conductive pollution occurs, or dry, non-conductive pollution occurs which becomes conductive due to condensation.

Pollution Degree 4:

The pollution generates persistent conductivity caused, for instance, by conductive dust or by rain or snow.

Below are a few examples of such environments.

| Pollution Degree 1 | Pollution Degree 2 | Pollution Degree 3 | Pollution Degree 4 |
|--------------------|--------------------|--------------------|--------------------------------------|
| Clean Rooms | Laboratories | Industrial Area | Electrical Equipment for outdoor use |
| | Test Stations | Boiler Rooms | |
| | Office Environment | | |



As per IEC, the products intended for a particular 'Pollution Degree' will have to follow the guidelines for clearance and creepage distances. Clearance is the distance between two conductive parts, along a string stretched at shortest way between these conductive parts. Creepage distance refers to the shortest distance along the surface of an insulation material between two conductive parts. Typically, the equipment for industrial applications are generally for use in pollution degree 3 environments.

b. Mechanical Impact Protection Index – IK

It is the degree of protection provided by distribution boards and enclosures for electrical equipment against external mechanical impacts as provided in the international standard IEC 62262. It provides a means of specifying the capacity of an enclosure to protect inside devices from external impacts.

| IK | IMPACT ENERGY (J) | EQUIVALENT IMPACT |
|----|-------------------|---------------------------------------|
| 00 | Unprotected | No Test |
| 01 | 0.14 | Drop of 250g object from 5.6cm height |
| 02 | 0.2 | Drop of 200g object from 10cm height |
| 03 | 0.35 | Drop of 250g object from 14cm height |
| 04 | 0.5 | Drop of 200g object from 25cm height |
| 05 | 0.7 | Drop of 250g object from 28cm height |
| 06 | 1 | Drop of 250g object from 40cm height |
| 07 | 2 | Drop of 500g object from 40cm height |
| 08 | 5 | Drop of 1.7kg object from 30cm height |
| 09 | 10 | Drop of 5kg object from 20cm height |
| 10 | 20 | Drop of 5kg object from 40cm height |

c. Degree of Protection – IP

As per IEC standard, Ingress Protection level IPXX is defined with two numerals. The first numeral defines protection against ingress of solid objects while the second numeral defines protection against harmful ingress of water.

Classification of IP Levels

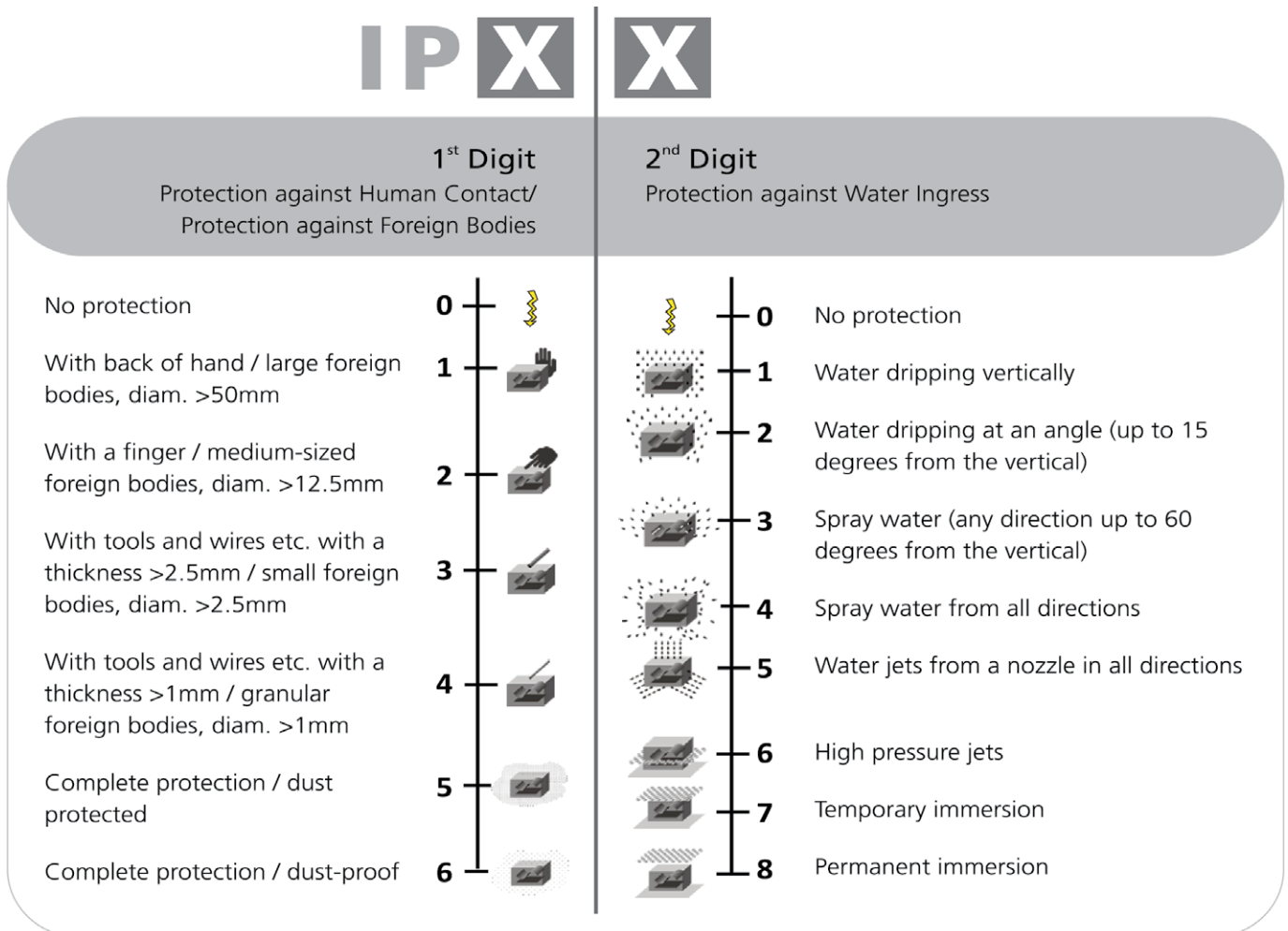



d. Suitability for Isolation

Certain devices are intended to provide isolation of the load from the source. Such devices can be termed 'suitable' for isolation provided they meet guidelines as indicated by IEC standard. Equipment suitable for isolation will have, in open position, an isolation distance in accordance with the requirements necessary to satisfy the isolation function. Further, the indication of the position of the main contacts is to be provided by one or more of the following means:

- The position of the actuator (or knob)
- A separate mechanical indicator
- Visibility of the moving contacts

A device suitable for isolation will bear an isolation function symbol. The example below shows a circuit-breaker suitable for isolation.



e. Energy Limiting Class (Reference EN 60898)

Circuit breakers are classified into different 'energy limiting classes' based on the amount of let-through energy (I^2t) they pass on to the downstream zone. The permissible let-through energy values, as per rated short-circuit breaking capacity and the characteristic curves are stated in the relevant product standard, EN 60898.

Energy Limiting Class 3, as defined, has lower let-through energy values than the other two classes.

MCBs

Temperature De-rating

As per IS/IEC 60898, thermal calibration of an MCB is to be done at 30°C. If the manufacturer decides to do it at any other temperature, the data has to be furnished on the breaker.

When used at ambient temperatures exceeding the calibrated temperatures, MCBs tend to trip faster while carrying the rated current. This calls for de-rating the MCBs when used in ambiances, with temperatures higher than the design ambient temperature. At temperatures higher than 30°C, the MCB requires progressively less time to trip on the same level of overload.

| MCB Temperature De-rating | | | | | | | | | | |
|---------------------------|------|---------------------|-------|-------|-------|-------|-----|-------|-------|-------|
| In [A] | [°C] | AMBEINT TEMPERATURE | | | | | | | | |
| | | -25 | -10 | 0 | 10 | 20 | 30 | 40 | 50 | 60 |
| 0.5 | | 0.675 | 0.63 | 0.595 | 0.565 | 0.53 | 0.5 | 0.46 | 0.425 | 0.39 |
| 1 | | 1.35 | 1.26 | 1.19 | 1.13 | 1.06 | 1 | 0.92 | 0.85 | 0.78 |
| 2 | | 2.7 | 2.52 | 2.38 | 2.26 | 2.12 | 2 | 1.84 | 1.7 | 1.56 |
| 3 | | 4.05 | 3.78 | 3.57 | 3.39 | 3.18 | 3 | 2.76 | 2.55 | 2.34 |
| 4 | | 5.4 | 5.04 | 4.76 | 4.52 | 4.24 | 4 | 3.68 | 3.4 | 3.12 |
| 6 | | 8.1 | 7.56 | 7.14 | 6.78 | 6.36 | 6 | 5.52 | 5.1 | 4.68 |
| 10 | | 13.5 | 12.6 | 11.9 | 11.3 | 10.6 | 10 | 9.2 | 8.5 | 7.8 |
| 16 | | 21.6 | 20.16 | 19.04 | 18.08 | 16.96 | 16 | 14.72 | 13.6 | 12.48 |
| 20 | | 27 | 25.2 | 23.8 | 22.6 | 21.2 | 20 | 18.4 | 17 | 15.6 |
| 25 | | 33.75 | 31.5 | 29.75 | 28.25 | 26.5 | 25 | 23 | 21.25 | 19.5 |
| 32 | | 43.2 | 40.32 | 38.08 | 36.16 | 33.92 | 32 | 29.44 | 27.2 | 24.96 |
| 40 | | 54 | 50.4 | 47.6 | 45.2 | 42.4 | 40 | 36.8 | 34 | 31.2 |
| 50 | | 67.5 | 63 | 59.5 | 56.5 | 53 | 50 | 46 | 42.5 | 39 |
| 63 | | 85.05 | 79.38 | 74.97 | 71.19 | 66.78 | 63 | 57.96 | 53.55 | 49.14 |



Grouping factor

Most of the time, MCBs are mounted in a stack or a group. The heating effect of these MCBs, when fully loaded, leads to considerable watt loss, and raises the temperature in the enclosure. The grouping factor for AU MCBs (0.5A-63A) is stated below.

| No of MCBs in a stack | Grouping Factor |
|-----------------------|-----------------|
| 1 | 1 |
| 2 | 0.95 |
| 3 | 0.9 |
| 4 and above | 0.85 |

Therefore, with the grouping factors listed above, the current rating of an MCB can be appropriately chosen.

Effect of frequency change

Magnetic - value multiplied by K

Thermal - unchanged

Current rating of an MCB can be appropriately chosen for different operating frequencies.

| Frequency(Hz) | 15Hz-60Hz | 100Hz | 200Hz | 400Hz |
|---------------|-----------|-------|-------|-------|
| K | 1 | 1.1 | 1.2 | 1.5 |

Different types of MCB curves

Based on the various magnetic settings, the MCBs can be categorized as shown below.

| Type | Magnetic setting | Application |
|------|------------------|--|
| B | 3-5 In | Generator-sensitive loads very long circuit runs Example: Incandescent lights, heater, geyser |
| C | 5-10 In | General, light and power Example: Flourescent lights, small motors, fans, refrigerators, window / split ACs |
| D | 10-20 In | Transformers sodium lighting highly inductive loads Example: Water lifting pumps, UPS |

AU-10 (MCBs) IT Characteristics

B Curve

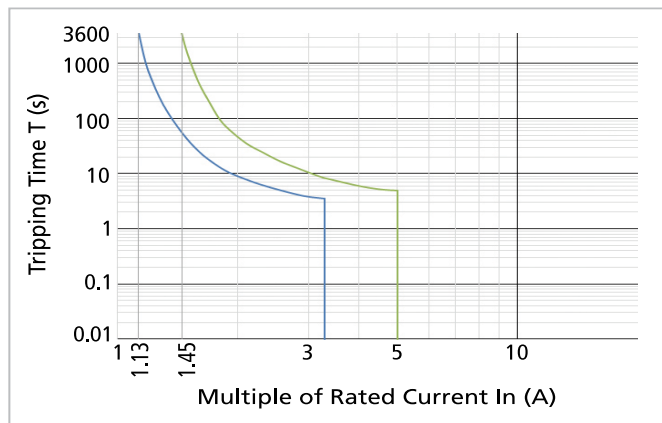

C Curve

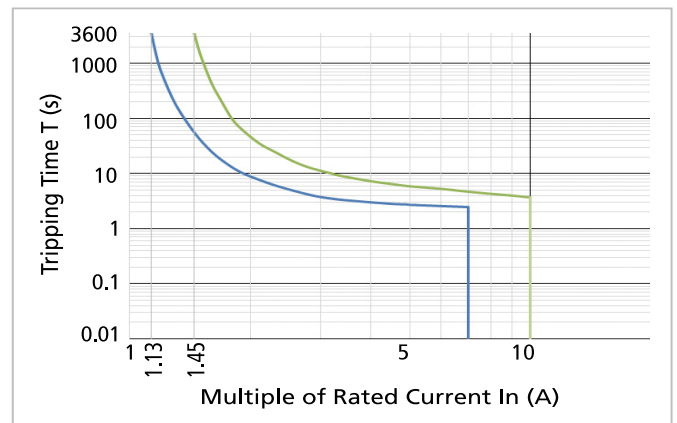

D Curve

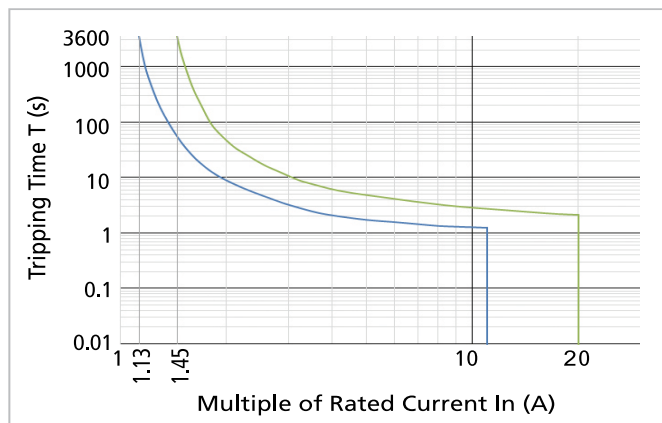



Current-limiting

Current limitation is the technique used in miniature circuit breakers to limit the short circuit current to reach its prospective value.

B Curve (6A-63A)

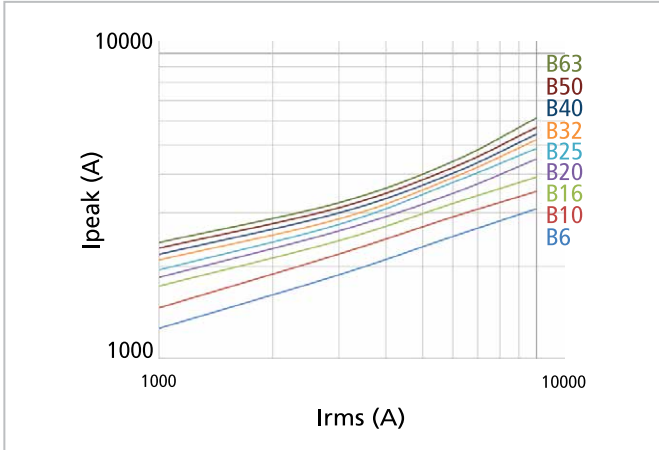

C Curve (6A-63A)

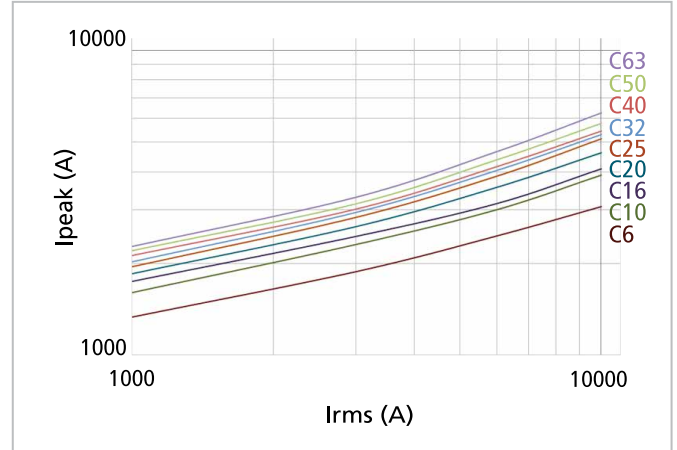

D Curve (6A-63A)

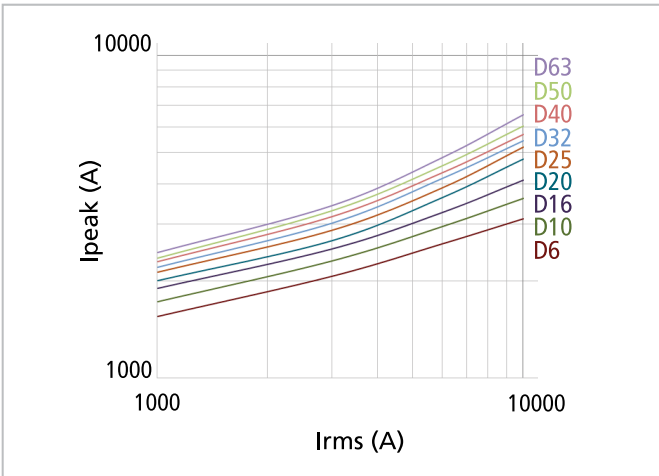

C Curve (0.5A-5A)

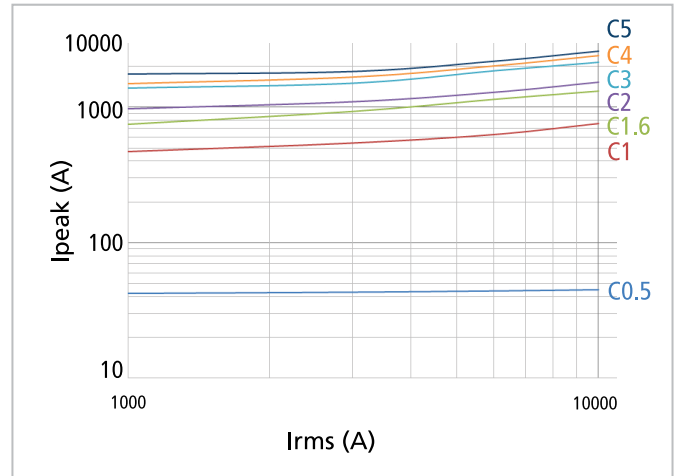

D Curve (0.5A-5A)

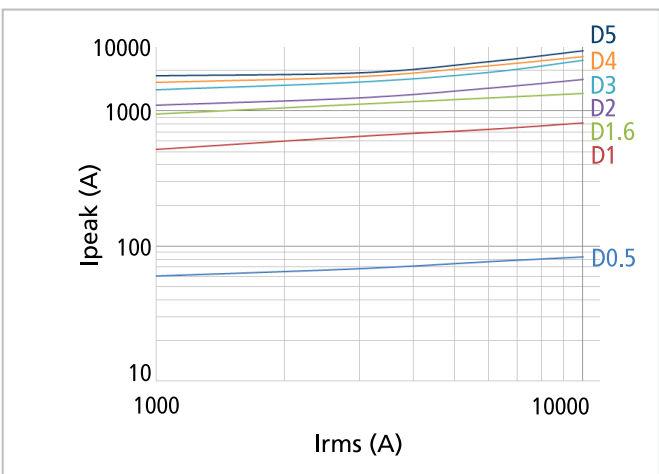



MCBs - Let Thru Energy - I^2t

Let Thru energy is the amount of fault energy which passes through a circuit breaker to the downstream network, measured from the instant a fault occurs in a system to the instant the miniature circuit breaker clears the fault.

B Curve (6A-63A)

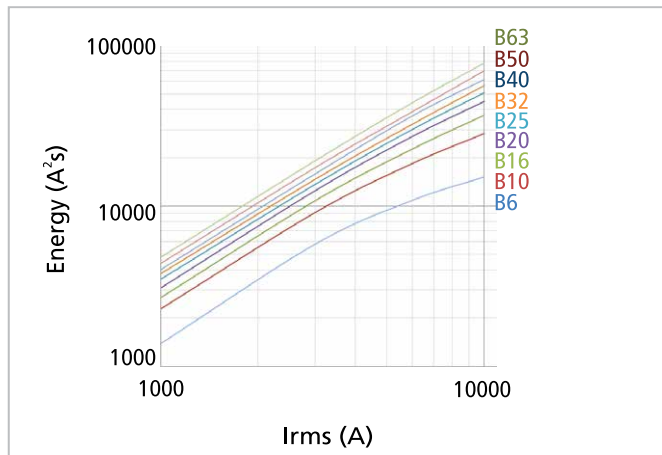

C Curve (6A-63A)

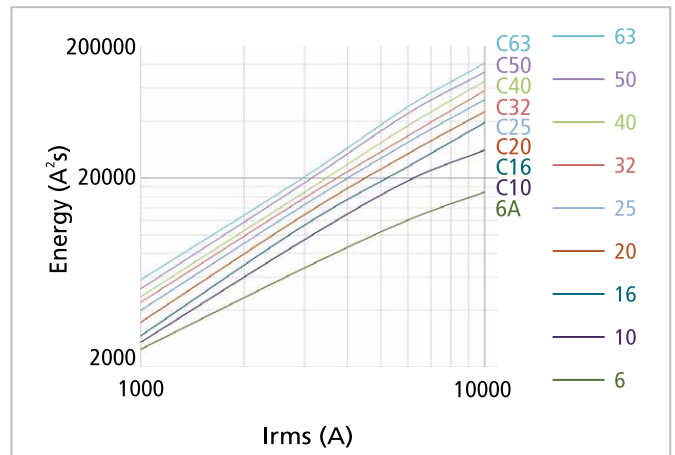

D Curve (6A-63A)

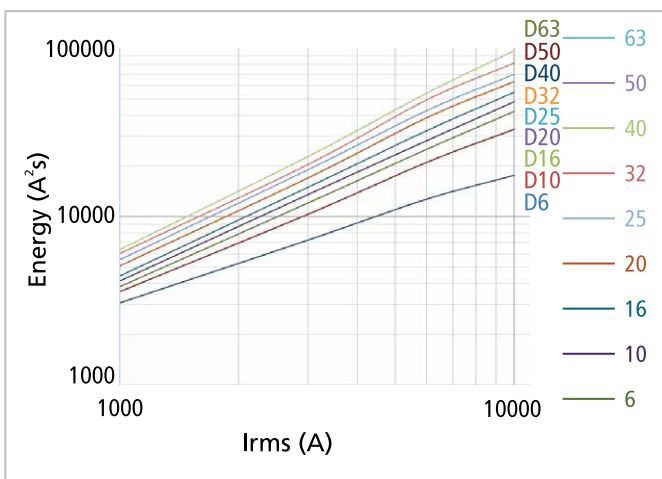

C Curve (0.5A-5A)

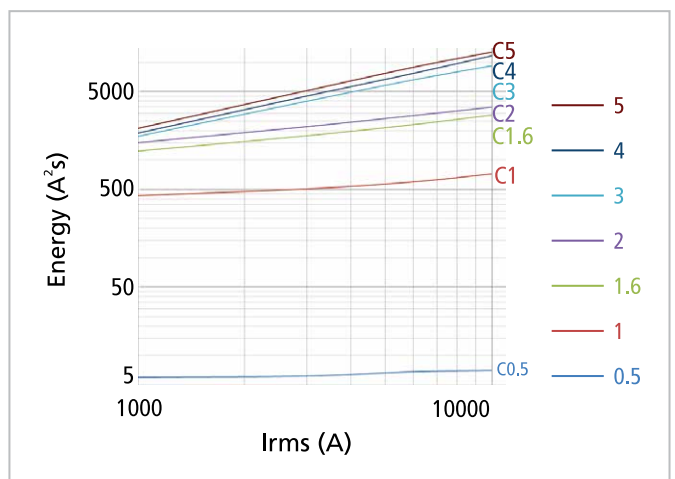

D Curve (0.5A-5A)

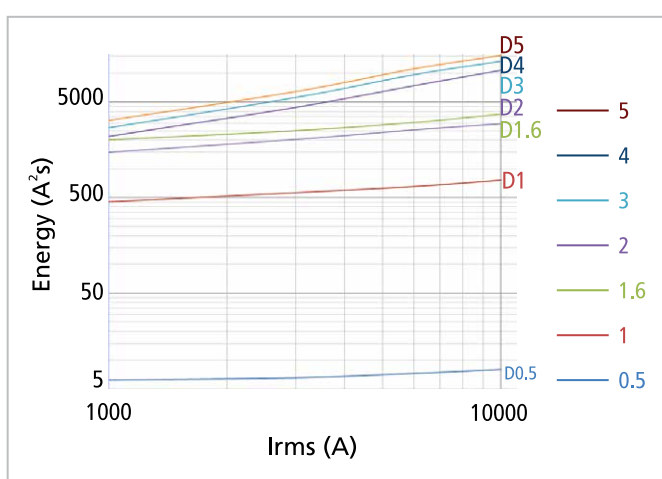

MCBs - Maximum Power Loss Per Pole (W)

| Current Ratings (A) | As Per IS/ IEC 60898 | For AU Range of MCBs | % lower |
|---------------------|----------------------|----------------------|---------|
| 0.5 | 3 | 1.9 | 38% |
| 1 | 3 | 2 | 33% |
| 1.6 | 3 | 2.1 | 30% |
| 2 | 3 | 2.1 | 30% |
| 3 | 3 | 2.1 | 30% |
| 4 | 3 | 2.1 | 30% |
| 5 | 3 | 2.1 | 30% |
| 6 | 3 | 1.1 | 63% |
| 10 | 3 | 1.2 | 60% |
| 16 | 3.5 | 1.8 | 50% |
| 20 | 4.5 | 1.9 | 58% |
| 25 | 4.5 | 2.1 | 54% |
| 32 | 6 | 2.4 | 60% |
| 40 | 7.5 | 3.1 | 59% |
| 50 | 9 | 4.1 | 54% |
| 63 | 13 | 4.3 | 67% |
| 80 | 15 | 3.9 | 74% |
| 100 | 15 | 6.2 | 59% |
| 125 | 20 | 9.2 | 54% |



RCBOs - Power loss (AU-O)

| Current (A) In | Watt Loss (W) |
|----------------|---------------|
| 6 | 1.1 |
| 10 | 1.2 |
| 16 | 1.8 |
| 20 | 1.9 |
| 25 | 2.1 |
| 32 | 2.4 |
| 40 | 3.1 |

RCBOs - Power loss (AU-F)

| Current (A) In | Watt Loss (W) |
|----------------|---------------|
| 16 | 2.6 |
| 20 | 2.7 |
| 25 | 3.1 |
| 32 | 3.6 |
| 40 | 4.8 |
| 63 | 8.1 |



RCBOs - Temperature De-rating (AU-O)

| RCBO Temperature De-rating | | | | | | | | | | |
|----------------------------|------|---------------------|-------|-------|-------|-------|----|-------|-------|-------|
| In [A] | [°C] | AMBIENT TEMPERATURE | | | | | | | | |
| | | -25 | -10 | 0 | 10 | 20 | 30 | 40 | 50 | 60 |
| 6 | | 8.1 | 7.56 | 7.14 | 6.78 | 6.36 | 6 | 5.52 | 5.1 | 4.68 |
| 10 | | 13.5 | 12.6 | 11.9 | 11.3 | 10.6 | 10 | 9.2 | 8.5 | 7.8 |
| 16 | | 21.6 | 20.16 | 19.04 | 18.08 | 16.96 | 16 | 14.72 | 13.6 | 12.48 |
| 20 | | 27 | 25.2 | 23.8 | 22.6 | 21.2 | 20 | 18.4 | 17 | 15.6 |
| 25 | | 33.75 | 31.5 | 29.75 | 28.25 | 26.5 | 25 | 23 | 21.25 | 19.5 |
| 32 | | 43.2 | 40.32 | 38.08 | 36.16 | 33.92 | 32 | 29.44 | 27.2 | 24.96 |
| 40 | | 54 | 50.4 | 47.6 | 45.2 | 42.4 | 40 | 36.8 | 34 | 31.2 |

RCCBs - Watt loss (AU-R)

| Current (A) | Watt Loss (W)-2P | Watt Loss (W)-4P |
|-------------|------------------|------------------|
| 16 | 0.3 | - |
| 25 | 0.7 | 0.8 |
| 40 | 2.3 | 2.3 |
| 63 | 4 | 4.7 |
| 80 | 4 | 4.8 |
| 100 | 6 | 6.7 |

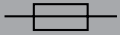
Short circuit withstand offered by RCCB

|  |  gl - 10kA With backup fuse | | | | |  230/400 V - 10 kA With backup MCB | | |
|---|--|-------|-------|-------|-------|---|-------|-------|
| | 25 A | 40 A | 63 A | 80 A | 100 A | 25 A | 40 A | 63 A |
| 16 A | 10 kA | 10 kA | 10 kA | 10 kA | 10 kA | 10 kA | 10 kA | 10 kA |
| 25 A | 10 kA | 10 kA | 10 kA | 10 kA | 10 kA | 10 kA | 10 kA | 10 kA |
| 40 A | | 10 kA | 10 kA | 10 kA | 10 kA | | 10 kA | 10 kA |
| 63 A | | | 10 kA | 10 kA | 10 kA | | | 10 kA |
| 80 A | | | | 10 kA | 10 kA | | | |
| 100 A | | | | | 10 kA | | | |

Electrical Standard Products (ESP) Offices:

HEAD OFFICE

L&T Business Park,
Tower 'B' / 3rd Floor
Saki Vihar Road, Powai
Mumbai 400 072
Tel: 022-67053229
Fax: 022-67051112
e-mail: cic@LNTEBG.com

BRANCH OFFICES

501, Sakar Complex I
Opp. Gandhigram Rly. Station
Ashram Road
Ahmedabad 380 009
Tel: 079-66304006-11
Fax: 079-66304025
e-mail: esp-ahm@LNTEBG.com

38, Cubbon Road, P. O. Box 5098
Bengaluru 560 001
Tel: 080-25020100 / 25020324
Fax: 080-25580525
e-mail: esp-blr@LNTEBG.com

131/1, Zone II, Maharana Pratap Nagar
Bhopal 462 011
Tel: 0755-3080511 / 05 / 08 / 13 / 17 / 19
Fax: 0755-3080502
e-mail: esp-bho@LNTEBG.com

Plot No. 559, Annapurna Complex
Lewis Road
Bhubaneswar 751 014
Tel: 0674-6451342 / 2436690 / 2436696
Fax: 0674-2537309
e-mail: esp-bsr@LNTEBG.com

Aspire Towers, 4th Floor
Plot No. 55, Phase-I
Industrial & Business Park
Chandigarh-160 002
Tel: 0172-4646840 / 41 / 42 / 46 / 53
Fax: 0172-4646802
Email: esp-chd@LNTEBG.com

L&T Construction Campus
TC-1 Building, II Floor
Mount-Poonamallee Road
Manapakkam
Chennai 600 089
Tel: 044-2270 6800
Fax: 044-22706940
e-mail: esp-maa1@LNTEBG.com

67, Appuswamy Road, Post Bag 7156
Opp. Nirmala College
Coimbatore 641 045
Tel: 0422-2588120 / 1 / 5
Fax: 0422-2588148
e-mail: esp-cbe@LNTEBG.com

1&2, Vijay Park, Main Chakrata road
Opp: Anandam, Ballapur Chowk
Dehradun 248001
Tel: 9582252411

Khairasol, Degaul Avenue
Durgapur 713 212
Tel: 0343-2540448 / 2540449 / 2540443
Fax: 0343-2540442
e-mail: esp-dgp@LNTEBG.com

5, Milanpur Road, Bamuni Maidan
Guwahati 781 021
Tel: +91 8876554410 / 8876554417
Fax: 361-2551308
e-mail: esp-ghy@LNTEBG.com

II Floor, Vasantha Chambers
5-10-173, Fateh Maidan Road
Hyderabad 500 004
Tel: 040-67015052
Fax: 040-23296468
e-mail: esp-hyd@LNTEBG.com

Monarch Building, 1st Floor
D-236 & 237, Amrapali Marg
Vaishali Nagar
Jaipur 302 021
Tel: 0141-4385914 to 18
Fax: 0141-4385925
e-mail: esp-jai@LNTEBG.com

Akashdeep Plaza, 2nd Floor
P. O. Golmuri
Jamshedpur 831 003
Jharkhand
Tel: 0657-2312205 / 38
Fax: 0657-2341250
e-mail: esp-jam@LNTEBG.com

Skybright Bldg; M. G. Road
Ravipuram Junction, Ernakulam
Kochi 682 016
Tel: 0484-4409420 / 4 / 5 / 7
Fax: 0484-4409426
e-mail: esp-cok@LNTEBG.com

3-B, Shakespeare Sarani
Kolkata 700 071
Tel: 033-42005982
Fax: 033-22821025 / 7587
e-mail: esp-ccu@LNTEBG.com

A28, Indira Nagar, Faizabad Road
Lucknow 226 016
Tel: 0522-4929905 / 04
Fax: 0522-2311671
e-mail: esp-lko@LNTEBG.com

No: 73, Karpaga Nagar, 8th Street
K. Pudur
Madurai 625 007
Tel: 0452-2567405 / 2561068 / 2561657
Fax: 0452-2567552
e-mail: esp-mdu@LNTEBG.com

L&T Business Park,
Tower 'B' / 5th Floor
Saki Vihar Road, Powai
Mumbai 400 072
Tel: 022-67052874 / 2737 / 1156
Fax: 022-67051112
e-mail: esp-bom@LNTEBG.com

12, Shivaji Nagar
North Ambajhari Road
Nagpur 440 010
Tel: 0712-2260012 / 6606421
Fax: 2260030 / 6606434
e-mail: esp-nag@LNTEBG.com

32, Shivaji Marg
P. O. Box 6223
New Delhi 110 015
Tel: 011-41419514 / 5 / 6
Fax: 011-41419600
e-mail: esp-del@LNTEBG.com

L&T House
P. O. Box 119
191/1, Dhole Patil Road
Pune 411 001
Tel: 020-66033395 / 66033279
Fax: 020-26164048 / 26164910
e-mail: esp-pnq@LNTEBG.com

Crystal Tower,
4th Floor, G. E. Road
Telibandha
Raipur - 492 006
Tel: 0771-4283214
e-mail: esp-raipur@LNTEBG.com

3rd Floor
Vishwakarma Chambers
Majura Gate, Ring Road
Surat 395 002
Tel: 0261-2473726
Fax: 0261-2477078
e-mail: esp-sur@LNTEBG.com

Radhadaya Complex
Old Padra Road
Near Charotar Society
Vadodara 390 007
Tel: 0265-6613610 / 1 / 2
Fax: 0265-2336184
e-mail: esp-bar@LNTEBG.com

Door No. 49-38-14/3/2, 1st floor,
NGGO's Colony, Akkayyapalem,
Visakhapatnam - 530 016
Tel: 0891-2791126 / 2711125
Fax: 0891-2791100
e-mail: esp-viz@LNTEBG.com

Product improvement is a continuous process. For the latest information and special applications, please contact any of our offices listed here.



Larsen & Toubro Limited, Electrical Standard Products
Powai Campus, Mumbai 400 072

Customer Interaction Center (CIC)

BSNL / MTNL (toll free) : 1800 233 5858 Reliance (toll free) : 1800 200 5858
Tel : 022 6774 5858 E-mail : cic@Lntebg.com / Website www.Lntebg.com

Registered Office: L&T House, N. M. Marg, Ballard Estate, Mumbai 400 001, INDIA **CIN:** L99999MH1946PLC004768